



W8 VERTIGO 30

sottovuoto verticale
vertical vacuum packaging machines

Sottovuoto compatta verticale ideale per liquidi, granulati e polveri per utilizzo nei bar o come seconda macchina.

- Max misura sacchetto mm 300x350 che riesce a contenere 3 Lt
- Controllo EASY TOUCH
- Coperchio senza pistoni
- Pratiche nicchie sul profilo uso maniglia
- Straordinaria soluzione brevettata per la pulizia interna:
- Fianchi laterali della vasca trasparenti offrono una visibilità perfetta all'interno vasca
- Fianchi laterali sono facilmente e completamente smontabili senza attrezzi per poter pulire agevolmente e a fondo dentro la vasca









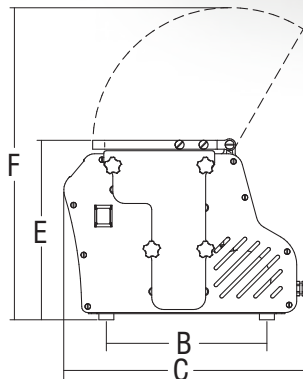
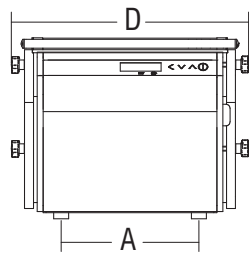
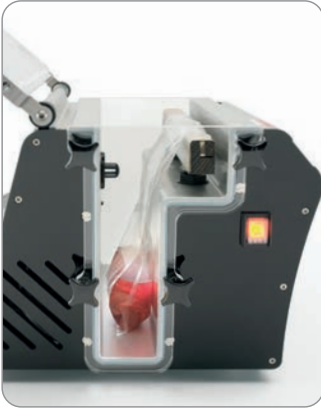







Vertical compact vacuum packaging machine ideal for liquids, granulates and powders best for bars or as a second machine.

- Max bag size 300x350 mm which can easily hold 3 Lt
- EASY TOUCH controls
- Lid without pistons
- Practical niches on the profile to move the unit
- Extraordinary patented solution for internal cleaning:
- Transparent sides of the tank offer perfect visibility inside the tank
- Side panels can be easily and completely disassembled without tools for easy and thorough cleaning inside the tank





														
	kw	1ph	mc/h	mm	mm	mm	mm	mm	mm	mm	mm	kg	mm	kg
Vertigo 30	0.15	1ph	4	310	326x60x250	230	268	416	396	300	521	22	515x435x385	24



Controllo EASY TOUCH

- Pratica e intuitiva tastiera Touch con WiFi integrato
- Facile settaggio del tempo di vuoto e di saldatura
- Visualizzazione percentuale vuoto e tempo residuo
- 10 programmi memorizzabili a piacere
- Programmi speciali:
 - Marinatura
 - Preriscaldamento pompa e ciclo pulizia olio
 - Vuoto esterno a tempo
- Memorizzazione ultima impostazione
- Contacicli utilizzo totale
- Messaggio cambio olio

EASY TOUCH Control

- Practical and intuitive touch keyboard with integrated WiFi
- Easy setting of the vacuum and sealing time
- Display shows vacuum percentage and time
- 10 programs that can be stored as desired
- Special programs:
 - Marinade
 - Pump preheating and oil cleaning cycle
 - Timed external vacuum
- Last setting memorization
- Total use cycle and time counter
- Oil change message



Controllo TOP

- Controllo touch intelligente, retroilluminato, completo ma intuitivo, con collegamento WiFi
 - Sistema di controllo elettronico con sensore di pressione per il vuoto automatico
 - Impostazione vuoto a Mbar, a Percentuale o a Tempo a preferenza dell'utente
 - Sensore di controllo di temperatura e protezione della pompa
 - Percentuale vuoto automatico regolabile 50-100% o a vuoto residuo in Mbar
 - Programma dedicato per liquidi
 - Programmi dedicati per marinatura
 - 10 programmi Multistep memorizzabili a piacere
 - 6 Lingue disponibili
 - Impostazione tempo saldatura, vuoto e gas con scala 1/10 sec.
 - Visualizzazione percentuale vuoto e tempo residuo
 - Previsione delle operazioni di manutenzione per garantire una maggior durata nel tempo
 - Segnale di avviso sostituzione olio e filtro
 - Ciclo di preriscaldamento e pulizia olio
 - Contacicli totali
 - Contatore utilizzo pompa
 - Softair elettronico con 3 livelli di regolazione
- Con questo controllo si possono integrare i seguenti optional *:
- Impianto gas inerte (MAP)
 - Stampante termica
 - A.O.R.
 - SanO3
 - SAT SYSTEM

* contatta il ns. ufficio per conoscere quali opzioni possono essere disponibili contemporaneamente sullo stesso apparecchio

TOP Control

- Smart, backlit, comprehensive yet intuitive touch control with WiFi connection
 - Electronic control system with pressure sensor for automatic vacuum
 - Vacuum setting at Mbar, Percentage or Time according to the user
 - Temperature control sensor and pump protection
 - Adjustable automatic vacuum percentage 50-100% or with residual vacuum in Mbar
 - Dedicated program for liquids
 - Dedicated programs for marinating
 - 10 Multistep programs that can be stored as desired
 - 6 Languages available
 - Setting sealing time, vacuum and gas with 1/10 sec scale
 - Displays vacuum percentage and remaining time
 - Predictive maintenance operations to ensure a longer duration over time
 - Oil and filter warning signal
 - Oil preheating and cleaning cycle
 - Total cycle counter
 - Pump usage hour counter
 - Electronic Softair with 3 adjustment levels
- This control can integrate the following options*:
- Inert gas system
 - Thermal printer
 - A.O.R.
 - SanO3
 - SAT SYSTEM

* contact our office to find out which options may be available at the same time on the same device