

1 Door Roma Rotating Oven

RIF. COD. FRIB

FEATURES	UM	Ø 115
Height of the cooktop	cm	120
Door width	cm	54/68
Power consumption	Kw	0,36
Total weight (standard finish)	Kg	1500
Capacity	nr.	7-8
Supply	Legna-Gas	
Under-floor burner		o
Minimum flue dimensions: Ø 20 cm		

AVAILABLE SHAPES



DIMENSIONS	UM	Ø 115
A - Depth	cm	177
B - Width	cm	172
C - Height	cm	195
D	cm	120
E	cm	112
F	cm	94
G	cm	135
External band projection over the feet of the oven cm 11		

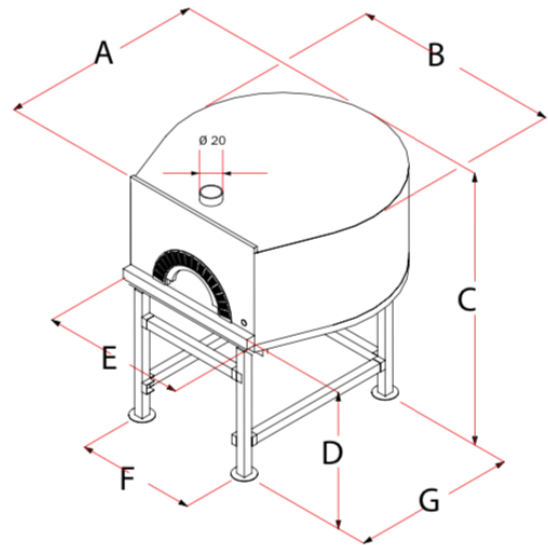

GAS DATA	UM	Ø 115
Thermal power	kW	34
LPG consumption	kg/h	2,681
Methane Consumption	m³/h	3,598
Flue gas temperature	°c	200
Draft	pascal	12 pa
Gas connection	inches	1/2
Type of construction		A1-BIIBS
energy Consumption	W	370

CAPACITY

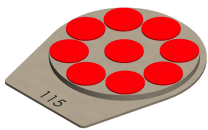

Ø 115