



Roma Traditional Oven

RIF. COD. T

FEATURES	UM	Ø 120
Height of the cooktop	cm	120
Door width	cm	54/68/82
Total weight (standard finish)	Kg	1700
Pizza Capacity	nr.	7-8
Minimum flue dimensions: Ø 20 cm		

DIMENSIONS	UM	Ø 120
A - Depth	cm	175
B - Width	cm	165
C - Height	cm	200
D	cm	120
E	cm	114
F	cm	100
G	cm	116
Headband foot overhang	cm	20

GAS DATA	UM	Ø 120
Thermal power	kW	34
LPG consumption	kg/h	2,681
Methane Consumption	m ³ /h	3,598
Flue gas temperature	°c	200
Draft	pascal	12 pa
Gas connection	inches	1/2
Type of construction		Al-BIIBS
Energy Consumption	W	100

AVAILABLE SHAPES

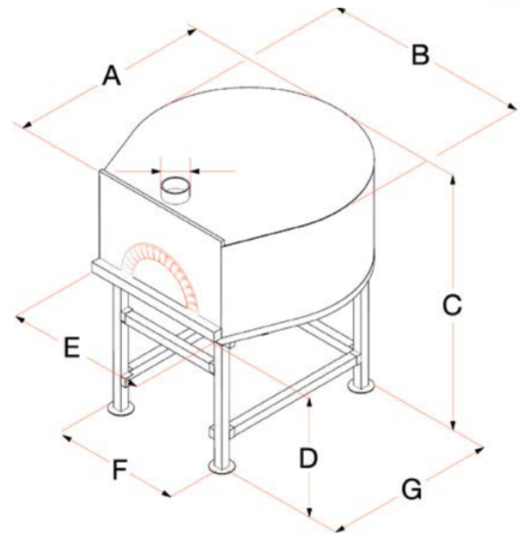

CAPACITY



Ø 120