

Nat 15



CAPACITY

15 TRAYS GN 1/1 H40 - H65

30 TRAYS GN 1/1 H20





30 TRAYS EN 60x40

+90
▼+3 | 68 kg | +90
▼-18 | 52 kg

PROGRAMS

Blast chilling	Shock freezing
Fish sanitizing	Thawing
Pre-cooling	Ice cream hardening
Bottle cooling.	Hot gas defrosting.
Cabinet drying.	Cabinet sanitizing

VERSIONI

	S Plug-in air condensing unit
	R Without condensing unit
	W Plug-in water condensing unit
	CO2 CO2 prearrangement





CONSTRUCTION FEATURES

- Adaptive 7" touch screen controller
- Monocoque construction.
- Internal and external construction in AISI 304 stainless steel.
- Stainless steel feet adjustable in height.
- Door gasket resistant to minimum reaching temperatures.
- Cabinet profiles and door profiles resistant to minimum temperatures.
- Technical compartment placed under the cabinet.
- Condensing unit placed in the technical compartment, removable and easily inspectable.
- Electrical panel with connectors, removable and easy to inspect.
- Multi-level adjustable stainless steel AISI 304 tray holder, suitable to hold GN 1/1 and EN 60x40 trays. Easily removable structure for cleaning operations.
- Internal cell with rounded corners to facilitate cleaning operations.
- CFC-free high density polyurethane insulation.
- Evaporator with cataphoresis rust protection.
- Left side door hinge.
- Heated door perimeter to avoid frost formation.





FUNCTIONS

- Probe cycles: the core probe temperature controls the cycle ensuring control and precision.
- Time cycles: the set duration controls the cycle.
- Timer cycles: 6 different timers can be set that automatically warn when the set duration is reached.
- Cascade cycles with multiple probes installed: the cycle allows to set a different target temperature for each installed core probe.
- Cascade cycles with one probe installed: this is a single-phase cycle with infinite time that allows different foodstuffs to be treated continuously without the need to act on the controller.
- Quick start: it is possible to choose a preferred cycle for quick start.
- Possibility to choose between factory preset cycles or to modify all the parameters of each cycle.
- Customizable multiphase cycles.
- Possibility to modify the parameters also during the current cycle.
- Rename of the display probes, to better distinguish the temperatures of each food.
- Graph of the temperatures during the current cycles.
- Recipe book for saving your favorite cycles.
- HACCP data storage with the possibility of downloading via usb key.

STANDARD EQUIPMENT

	n° 1 multi-point core probe.
	AISI 304 stainless steel tray holder for GN 1/1 and EN 60x40.
	Stainless steel feet adjustable in height.
	Condensing tray, placed on the bottom of the machine.

OPTIONAL EQUIPMENT

	Ozone generator for cabinet sanitization cycles.
	Predisposition for 4 core probes (1 probe included).
	Additional core probe.
	Kit of casters.

Technical data	S	R	W	CO2
Cooling capacity (Evap. -10°C / Cond. 45°C)	7626 W	-	7626 W	-
Cooling capacity requested	-	7626 W	-	7626 W
Liquid line	-	3/8" [10] mm	-	3/8" [10] mm
Suction line	-	1/2" [12] mm	-	1/2" [12] mm
Condensation	self-contained air	remoto	autonomo acqua	remoto
Refrigerant gas	R452A	R452A	R452A	R744
GWP	2141	2141	2141	1
Climate class	4	4	4	4
Power supply (Ph / Volts / Hz)	380-420/3N/50	220-240/1N/50	380-420/3N/50	220-240/1N/50
Max. power consumption cold cycles	4881 W - 10.28 A	548 W - 2.96 A	4701 W - 9,46 A	510 W
Blast chilling (+90 °C, +3 °C)	68 kg	68 kg	68 kg	68 kg
Shock freezing (+90°C, -18°C)	52 kg	52 kg	52 kg	52 kg
Internal dimensions (w x p x h)	650 x 433 x 1210 mm	650 x 433 x 1210 mm	650 x 433 x 1210 mm	650 x 433 x 1210 mm
External dimensions (w x p x h)	750 x 864 x 2020 mm	750 x 864 x 2020 mm	750 x 864 x 2020 mm	750 x 864 x 2020 mm
Capacity (liter)	341 L	341 L	341 L	341 L
Packaging dimensions	800 x 890 x 2174 mm	800 x 890 x 2174 mm	800 x 890 x 2174 mm	800 x 890 x 2174 mm
Packing volume	1.5 m ³	1.5 m ³	1.5 m ³	1.5 m ³
Gross weight	233 kg	215 kg	233 kg	215 kg

EN22042					
+65°C +10°C	kWh/Kg	0,088	+65°C -18°C	kWh/Kg	0,261
	Min.	88		Min.	248
	Kg	63		Kg	42

GASTRONOMIA / GASTRONOMY

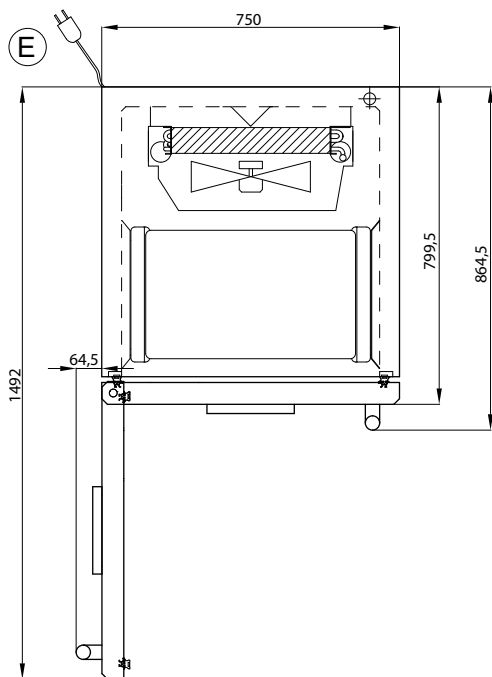
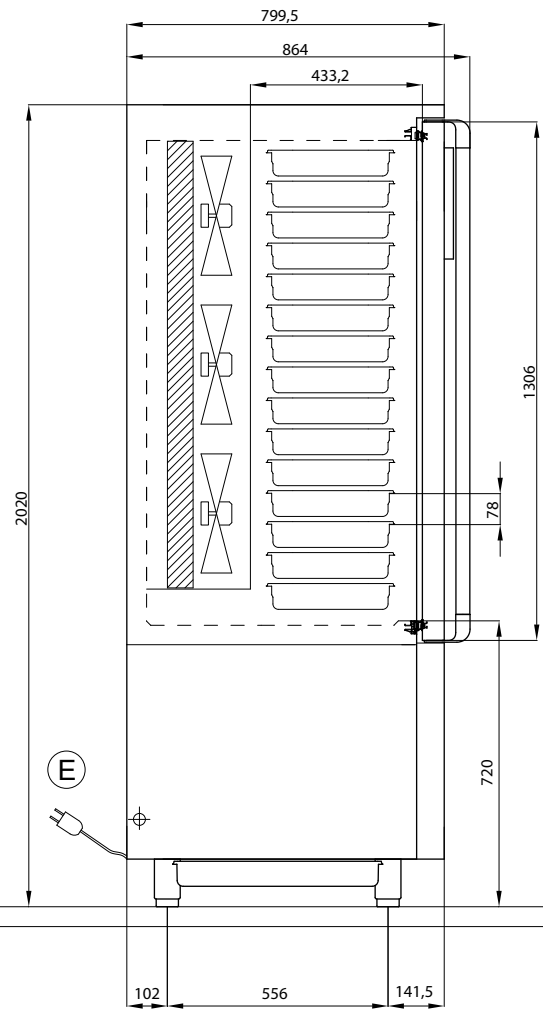
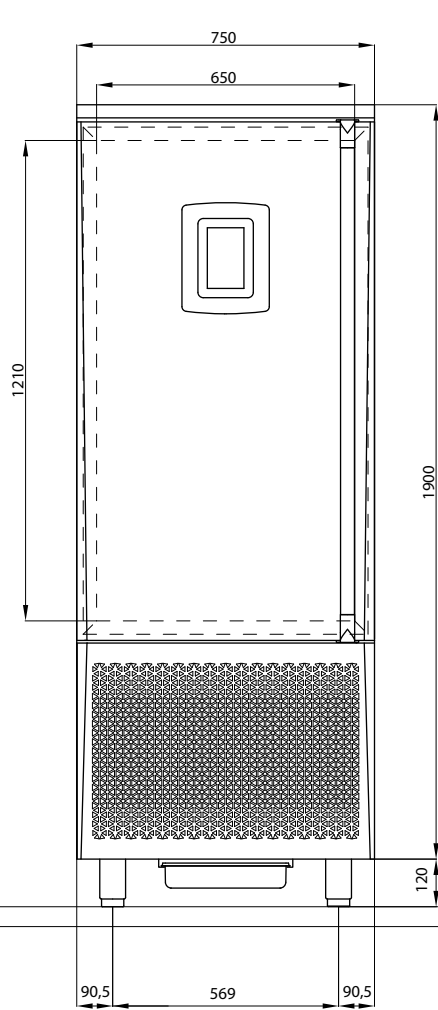

 H MIN 120
H MAX 165

 CONNESSIONE ELETTRICA
ELECTRICAL CONNECTION

PASTICCERIA / PASTRY

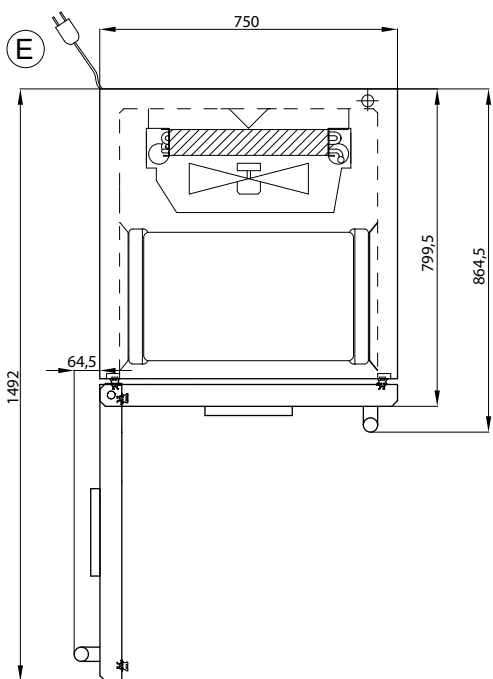
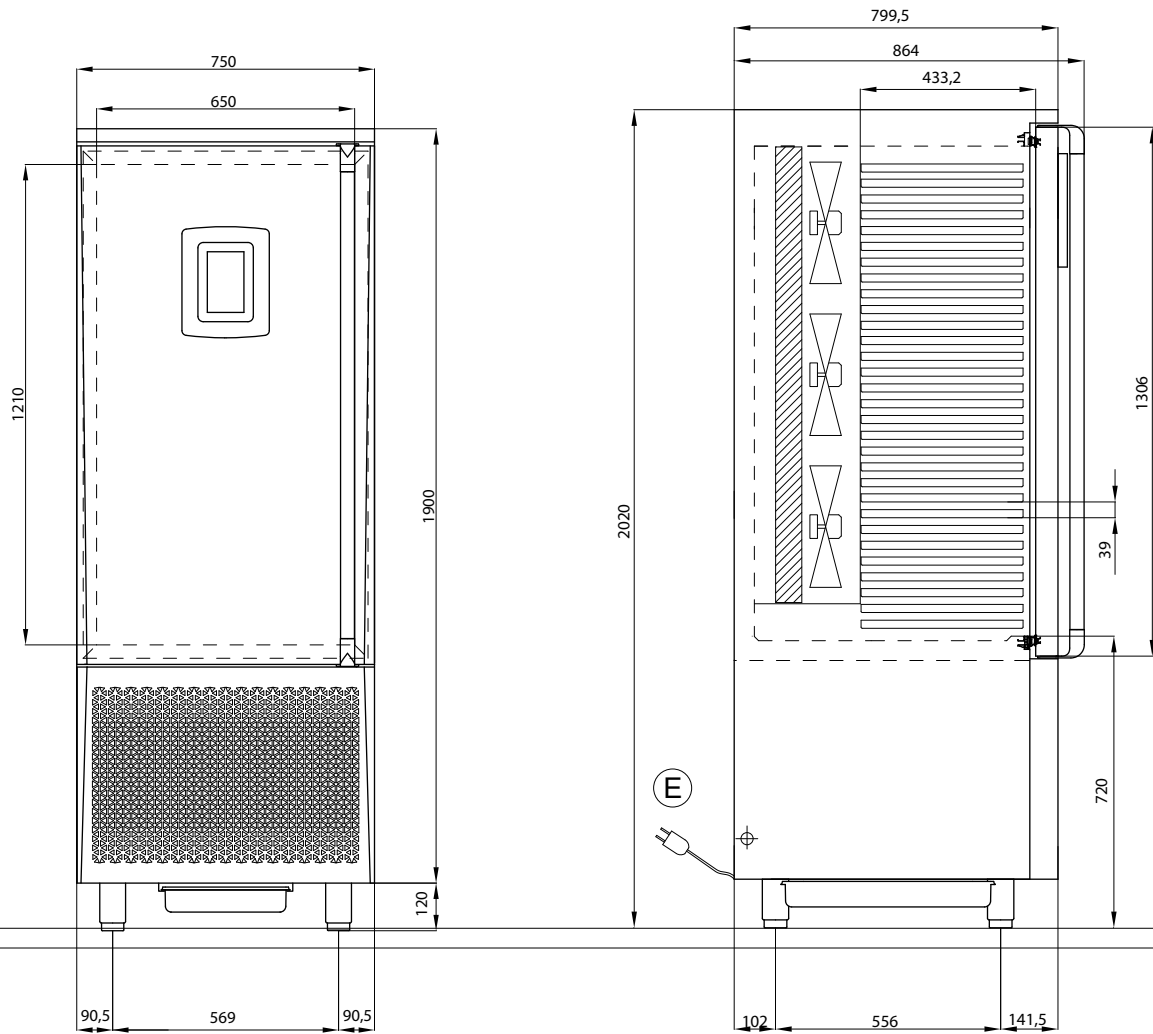

 H MIN 120
H MAX 165

 CONNESSIONE ELETTRICA
ELECTRICAL CONNECTION

GELATO / ICE CREAM

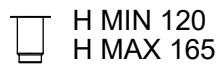
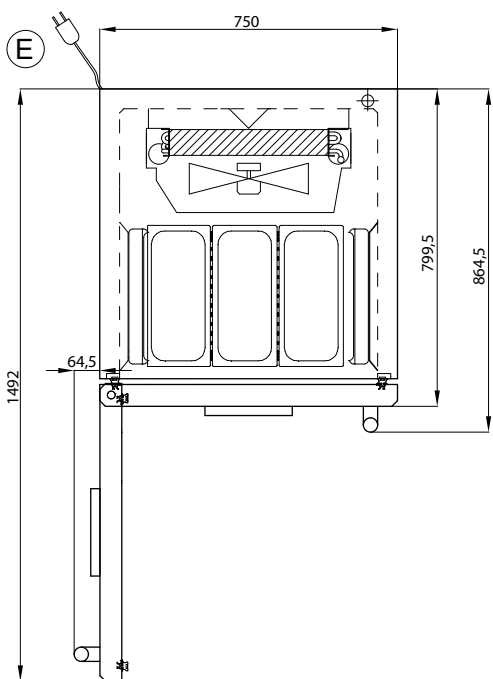
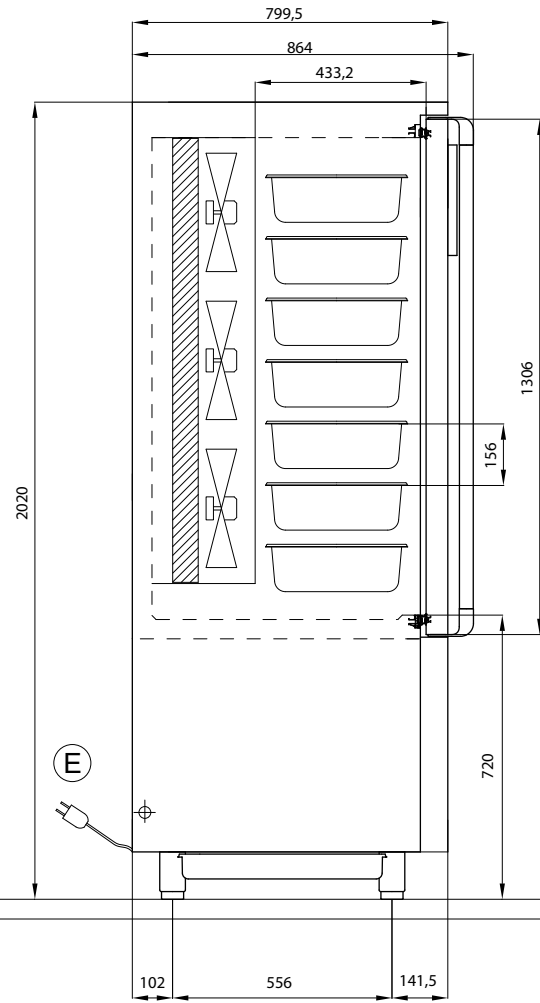
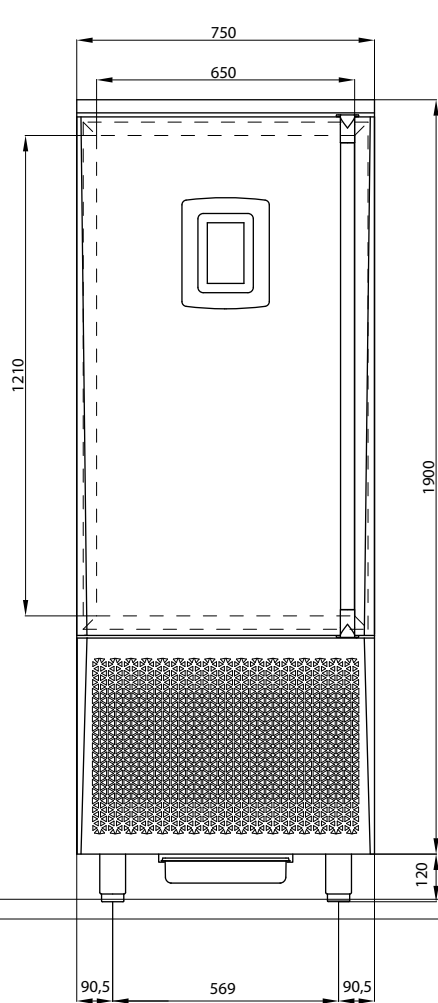

(E) CONNESSIONE ELETTRICA
ELECTRICAL CONNECTION