



# Deep frying technology

Operational user guide for deep fat fryers

**...when Innovation, Precision and Ecology work together in perfect harmony**





## Tasty frying when quality counts

Do you need a deep fat fryer, which inspires your staff? Through user friendliness, we can offer your guests the crispiest delicacies thanks to intelligent technology!

Then our models are an adequate solution! You have the choice to choose from a range of specialised and diverse equipment which come in different sizes to suit your specific needs. It doesn't matter which models you will decide – you can rely on one: Kienle Deep Frying Technology offer guaranteed return of investment and guaranteed solutions to your frying desires.



## The result

Professional deep frying can be tricky. We have taught our computers that you only have to press one button. Expensive and qualified staff are no longer needed. We therefore make it possible for you, the consumer, that you enjoy your frying time in less time. It offers your guests an „easy-going crunchy enjoyment“  
– Due to intelligent techniques we can ensure that your fried food is easily digestible and safe to consume.

With the purchase of a Kienle deep fat fryer you do not simply decide for any product: Quality stands for highest deep frying competence in its purest way. Thanks to our experience and specialised knowledge we create continuous innovative technology which you as a customer will directly profit from. In return of purchase, our products will provide you with the highest level of technology with superior design, all manufactured in Germany – Products with guaranteed life which even survive under the very hardest conditions.



The operation units, **Sirius** and **Primus**, will not let you down! With two controls, it couldn't be easier! Not only, it's even easy to use which makes frying fun and easy.

The third button is the management function which allows you to programme to your desired tailored needs and requests. In addition, the signal display, which adjusts its colors to the specified programming you request. It's just simply ingenious!

The signal field is changes like a chameleon, always adjusted to the certain operating modes.



## Sirius



A practical rotary knob offers solid technology – easy to use and is made to last. The temperature can be chosen in increases of 5 degrees between the temperatures of 145°Celsius and 180° Celsius.



Even though you are now up-to-date with our Sirius knob control, there is also a frying program ready available to your desired need.

## Primus



This frying computer is our masterpiece: One touch of a button – and your chips, spring rolls, chicken etc... Automatically pass through. It's the perfect frying process! This specific and unique service offers efficiency, cleanliness and is of course cooked through thoroughly to recommended eatable standards of 70 - 80 degrees plus. Furthermore, the device confines through an automatic quantity controller which configures and manages your frying time.



You can choose between 10 different possibilities with the program button.



You can start the pump with the pump button (only with the option filtering system), also it serves other diverse functions.

**pr01**

The info field will direct you to more specific and precise information if needed/requested.



All strings are pulled in the control and energy center. In compact sealed casings are processed all signals and commands are transmitted to switchgears through intelligent control.

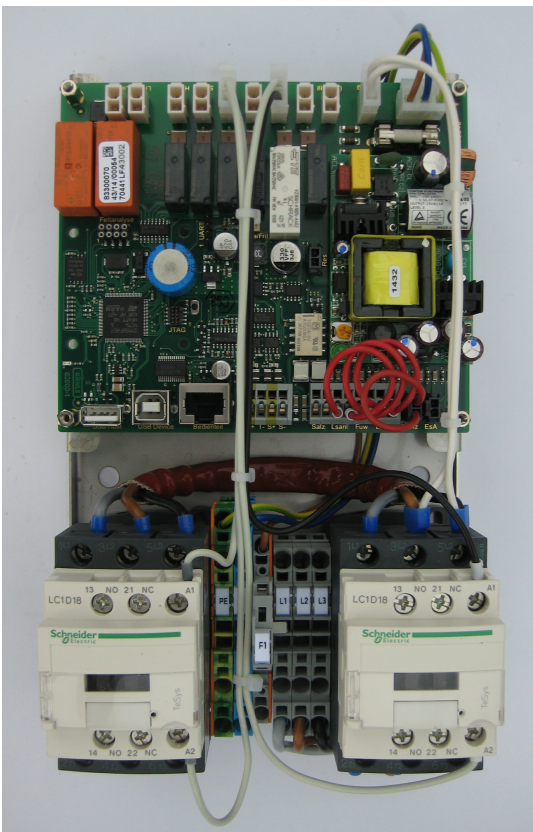

We had not worried about saving costs to reach an optimum of security. A separate safety circuit is always controlling the safety of this purchased product with regards to the safety probe and oil content.

A thermocouple is used with a metal sleeve which provides an accurate and precise temperature measurement. Due to safety conditions, an electronic thermostat is included with its own circuit which guarantees that additional safety for you the consumer.

Swing-out heaters allow for a practical draining and positioning. These heaters lift out of the oil tank and thus help and facilitate your cleaning. Whilst cleaning this device will automatically switch off.



## So, what that small genius of a product can do for you:

Amongst all product types there is an integrated fat-rendering cycle for careful melting of fat deposits.

The standby program can help to facilitate and reduce your frying time.

The frequency of fat and oil usage is monitored and displayed during every „start-up“ of the program.

Furthermore, you can select other additional services such as the „shaker function“ or end action e.g. signal, lift or signal + lift.

# Ecology | Showing commitment to save our environment

Minimise your energy usage and utilise the ultimate improved technology with economic efficiency. During our development this was already in our focus!

With the heating power of a conventional fryer you can heat a one-family house nowadays. You need less than 30 % of that power for frying. Therefore, 70 % of eating power deflagrates in our environment and affects your kitchen. Right here are our recent developments which innovate and create your ideal „new way“ of deep-frying!

## Heat effort

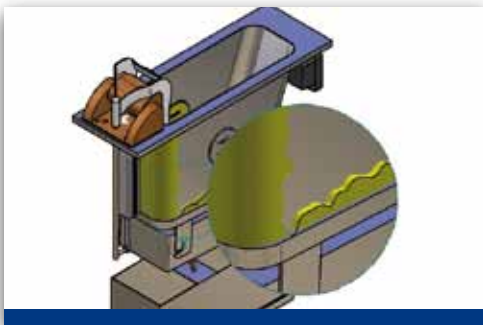

Concentrate heat where it is needed – in the oil tank. **The result:** A high quality surface area insulation of oil tanks reduces heat dissipation by app. 25%

## Peripheral savings



You can clean in less time, the oil tanks are furnished with large radii through complete swing-out heaters. **The result:** reduced time during cleaning.

**Energy saving** compared with a conventional deep fat fryer

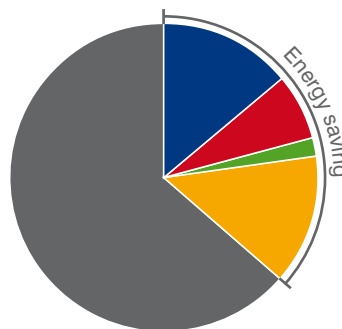

- 14%
- 7%
- 2%
- 13,5%

## Energy effort

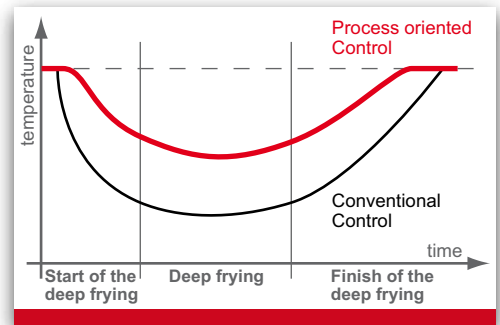

Intelligence technology which controls energy efficiency at the right time and at the right place. The result: process-orientated heat power control reduces the connected value (by app. 15%)

## Fat maintenance



You can execute fat maintenance in less time through the filtering and pump system. Thereby you improve your fried food as well record your fat usages, and in this case it is monitored by computer. Your advantage: Fat maintenance is cost efficient

## The daily fat maintenance

### The manual solution



#### **One manipulation suffices.**

Through opening the drain plug, oil runs through two filters, one above the other. Particles and impurities will remain and the clean oil is filtered in collecting tanks.



#### **Double guarantee of cleanliness.**

A coarse filter and a fine filter ensure an optimal collection of frying remnants after the cleaning process.

### The professional solution



#### **Completely automatic.**

The cleaned oil runs back in the tank.



#### **Clean disposal:**

The system enables an easy drainage of used oil in a transport or waste oil barrel.

## Device configuration

- ✓ Casings made of chromium-nickel steel
- ✓ Frying tank (30cm)
- ✓ Tank insulation 100% surface area
- ✓ Swing-out heater (for draining and cleaning)
- ✓ Basket holder can be hooked out
- ✓ Collecting tanks with telescopic extraction and coarse filter
- ✓ Collecting tanks with telescopic extraction and pumping system
- ✓ Height-adjustable feet

## Controller configuration

- ✓ Completely enclosed control box
- ✓ Electronic temperature control  $\pm 2^{\circ}\text{C}$
- ✓ Direct temperature scanning of oil
- ✓ Separate safety circuit
- ✓ Double try-out protection
- ✓ Standard equipped with standby function and fat rendering cycle
- ✓ Frying time detection with display indicator (program countdown time)
- ✓ Connection with power limitation with display
- ✓ Connection for extinguishing system with error message and lift using
- ✓ Connection with external fat monitoring and heating time recording

**Type Primus:** : 10 frying programs with a flat control panel

**Type Sirius:** rotary knob regulation with 1 frying program



Type VX 21 S

Type VX 31 P

Type VX 41 P

Type VX 41 T

Type VX 42 P

Type VX 62 S

Type Silofritt

## Weight and filling quantity

Type	Net weight	Oil capacity		Fill volume of baskets	Recommended fill volume	Number of baskets	Capacity/Hour	
		Min.	Max.				Frozen chips	Pre-cooked ch.
VX 21	kg	7	9	1,25 kg	0,90 kg	1	17 - 22 kg	20 - 25 kg
VX 31	kg	13	16	1,50 kg	1,00 kg	1	27 - 32 kg	30 - 35 kg
VX 41	kg	18	23	2x1,25 kg	2x0,90 kg	2 (1)	2x17 - 22 kg	2x20 - 25 kg
VX 41	kg	18	23	2x1,25 kg	2x0,90 kg	2	2x17 - 22 kg	2x20 - 25 kg
VX 42	kg	2x7	2x9	2x1,25 kg	2x0,90 kg	2	2x17 - 22 kg	2x20 - 25 kg
VX 62	kg	2x13	2x16	2x1,5 kg	2x1 kg	2	2x27 - 32 kg	2x30 - 35 kg

Modell 21

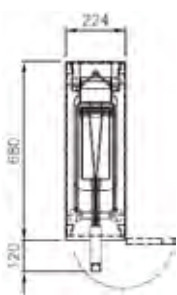

Modell 31

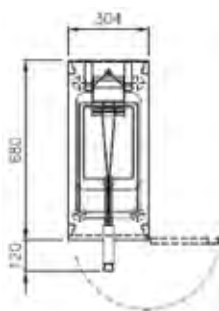

Modell 41 | 41T | 42

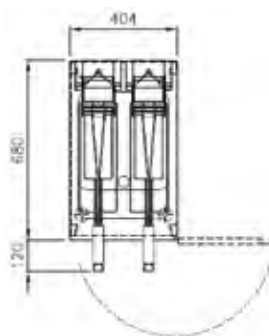

Modell VX 62

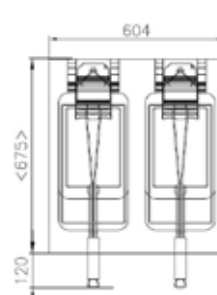

alle Modell

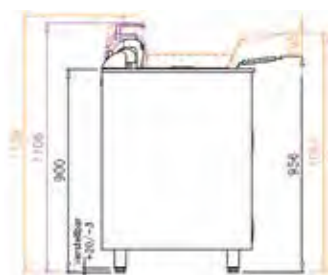

Type	Performance	Voltage	Fuse / Amps	Mains connection
VX 21	7,5 kW   5 W/cm <sup>2</sup>	3NAC400V   50/60 Hz	3x16 A	3L + N + PE
VX 31	11 kW   4,7 W/cm <sup>2</sup>	3NAC400V   50/60 Hz	3x16 A	3L + N + PE
VX 41	15 kW   5 W/cm <sup>2</sup>	3NAC400V   50/60 Hz	3x25 A	3L + N + PE
VX 41 T	15 kW   5 W/cm <sup>2</sup>	3NAC400V   50/60 Hz	3x25 A	3L + N + PE
VX 42	15 kW (2x7,5)   5 W/cm <sup>2</sup>	3NAC400V   50/60 Hz	3x25 A	3L + N + PE
VX 62	2 x 11 kW   4,7 W/cm <sup>2</sup>	3NAC400V   50/60 Hz	2x 3x16 A	3L + N + PE
Silofritt	0,65 kW	1NAC230V   50/60 Hz	1x16 A	1L + N + PE

Your Contract Partner

[www.kienle-fritteusen.de](http://www.kienle-fritteusen.de)

Kienle GmbH  
Nelkenstraße 3  
72469 Meßstetten-Hartheim

Tel.: 0 75 79 / 920-0  
Fax: 0 75 79 / 920-20  
Email: info@kienle-fritteusen.de