

Accessories Metric



flexeserve **Zone**[®]
true hot-holding | flexible merchandising

2 Tier Rack

Increase your capacity by 50% and present products in the best way using the 2 tier rack

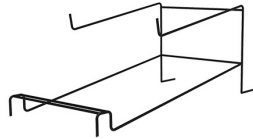

Condiment Baskets

The ideal way to offer impulse add-on sales of jams, honey, sauces and dressings to complement your hot products. Simply hook onto the shelf in front of your porridge, breakfast sandwiches, fries and more.



Angled Merchandising Insert

Angle products towards the customer's view to showcase colourful foods and create more visual impact.



Dividers

Use the handy dividers to separate different foods on the angled merchandising insert.



Merchandising Rack - Narrow

Present your hash browns, pizza slices, flatbreads and more in the perfect way for visual impact, whilst at the same time increasing capacity.

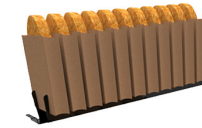

Merchandising Rack - Standard

Perfect for displaying breakfast sandwiches, paninis, wraps and burritos. Double your product volume and improve visibility with one accessory.

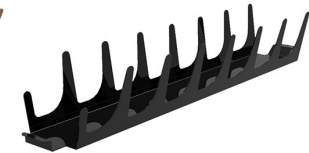

Merchandising tray





Merchandise your products back-of-house for an efficient way of filling Flexeserve Zone®. Merchandising racks easily click into the trays for a safe way of transporting to front-of-house. Trays can also slot into the angled merchandising insert for improved product visibility.







Fan Guard

Protect the fan plate from being blocked by food packaging and maintain full air flow.

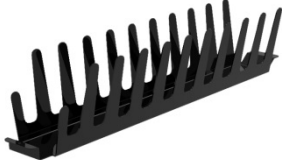
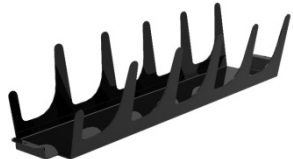

ORDER/IBS NAME	PRODUCT NAME	PRODUCT DESCRIPTION	VISUAL	DIMENSIONS	UNIT COMPATIBILITY	
Countertop Flexeserve Zone® Accessories						
10081944	Angled Merchandising Insert	Angle products towards the customer's view to showcase colourful food and create more visual impact. x1 Required to fill each zone shelf.		326mm (W) 361mm (D) 40mm - 86mm (H)	2 Tier	
					400	✓
					600	
					1000	
10081945	Angled Merchandising Insert	Angle products towards the customer's view to showcase colourful food and create more visual impact. x1 Required to fill each zone shelf.		526mm (W) 361mm (D) 40mm - 86mm (H)	2 Tier	
					400	
					600	✓
					1000	
10081942	Angled Merchandising Insert	Angle products towards the customer's view to showcase colourful food and create more visual impact. x2 Required to fill each zone shelf.		470mm (w) 361mm (D) 40mm - 86mm (H)	2 Tier	
					400	
					600	
					1000	✓
10081949	Merchandising Tray	Merchandise your products back-of-house for an efficient way of filling Flexeserve Zone® Trays can also slot into the angled merchandising insert for improved product visibility. x1 Required to fill each zone shelf.		318mm (W) 396mm (D) 30mm (H)	2 Tier	
					400	✓
					600	
					1000	

10083544	Merchandising Tray	<p>Merchandise your products back-of-house for an efficient way of filling Flexeserve Zone® Trays can also slot into the angled merchandising insert for improved product visibility.</p> <p>x2 Required to fill each zone shelf.</p>		<p>261mm (W) 396mm (D) 30mm (H)</p>	2 Tier	
					400	
					600	✓
					1000	
10081951	Merchandising Tray	<p>Merchandise your products back-of-house for an efficient way of filling Flexeserve Zone® Trays can also slot into the angled merchandising insert for improved product visibility.</p> <p>x4 Required to fill each zone shelf.</p>		<p>230mm (W) 396mm (D) 30mm (H)</p>	2 Tier	
					400	
					600	
					1000	✓
10081948	Merchandising Rack - Narrow	<p>Present your hash browns, pizza slices, flatbreads and more in the perfect way for visual impact, whilst at the same time increasing capacity.</p> <p>Recommended use with Merchandising Trays.</p>		<p>44mm (W) 385mm (D) 74mm (H)</p>	2 Tier	
					400	✓
					600	✓
					1000	✓
10081946	Merchandising Rack - Standard	<p>Perfect for displaying breakfast sandwiches, paninis, wraps and burritos. Double your product volume and improve visibility with one accessory.</p> <p>Recommended use with Merchandising Trays.</p>		<p>68mm (W) 386mm (D) 74mm (H)</p>	2 Tier	
					400	✓
					600	✓
					1000	✓

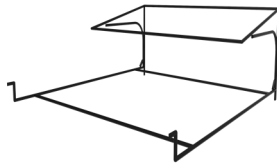
10082302	Divider	<p>Use the handy dividers to separate different foods on the angled merchandising insert.</p> <p>Recommended for use with Angled Merchandising Inserts.</p>		<p>3mm (W) 376mm (D) 50mm (H)</p>	2 Tier	
					400	✓
					600	✓
					1000	✓
10083584	2 Tier Rack	<p>Increase your capacity by 50% and present products in the best way using the 2 tier rack.</p> <p>x 1 Required to fill each 400 & 600 zone shelf.</p> <p>x2 Required to fill each 1000 zone shelf.</p>		<p>200mm (W) 410mm (D) 170mm (H)</p>	2 Tier	
					400	✓
					600	✓
					1000	✓

Merchandising Rack - Narrow

Present your hash browns, pizza slices, flatbreads and more in the perfect way for visual impact, whilst at the same time increasing capacity.

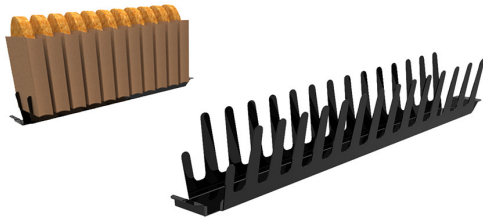

Angled Merchandising Insert

Angle products towards the customer's view to showcase colourful foods and create more visual impact.



Condiment Baskets

The ideal way to offer impulse add-on sales of jams, honey, sauces and dressings to complement your hot products. Simply hook onto the shelf in front of your porridge, breakfast sandwiches, fries and more.



Merchandising tray

Merchandise your products back-of-house for an efficient way of filling Flexeserve Zone®. Merchandising racks easily click into the trays for a safe way of transporting to front-of-house. Trays can also slot into the angled merchandising insert for improved product visibility.



Fan Guard

Protect the fan plate from being blocked by food packaging and maintain full air flow.

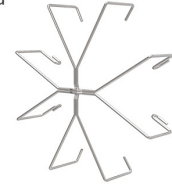

Merchandising Rack - Standard

Perfect for displaying breakfast sandwiches, paninis, wraps and burritos. Double your product volume and improve visibility with one accessory.



Dividers





Use the handy dividers to separate different foods on the angled merchandising insert.



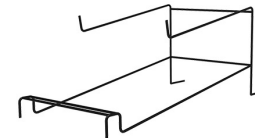



2 Tier Rack



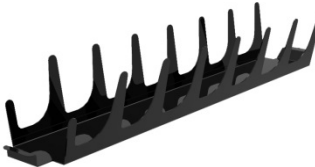

Increase your capacity by 50% and present products in the best way using the 2 tier rack



ORDER/IBS NAME	PRODUCT NAME	PRODUCT DESCRIPTION	VISUAL	DIMENSIONS	UNIT COMPATIBILITY					
Free Standing Flexeserve Zone® Accessories										
10081962	Angled Merchandising	Angle products towards the customer's view to showcase colourful food and create more visual impact. x1 Required to fill each zone shelf.		326mm (W) 495mm (D) 40mm - 102mm(H)	3 Tier		4 Tier		5 Tier	
					400	✓	400	✓	N/A	
					600		600		600	
					1000		1000		1000	
10082012	Angled Merchandising	Angle products towards the customer's view to showcase colourful food and create more visual impact. x1 Required to fill each zone shelf.		526mm (W) 495mm (D) 40mm - 102mm(H)	3 Tier		4 Tier		5 Tier	
					400		400		N/A	
					600	✓	600	✓	600	✓
					1000		1000		1000	
10082015	Angled Merchandising	Angle products towards the customer's view to showcase colourful food and create more visual impact. x2 Required to fill each zone shelf.		470mm (W) 495mm (D) 40mm - 102mm(H)	3 Tier		4 Tier		5 Tier	
					400		400		N/A	
					600		600		600	
					1000	✓	1000	✓	1000	✓
10082599	Merchandising Tray	Merchandise your products back-of-house for an efficient way of filling Flexeserve Zone® Trays can also slot into the angled merchandising insert for improved product visibility. x1 Required to fill each zone shelf.		320mm (W) 530mm (D) 30mm (H)	3 Tier		4 Tier		5 Tier	
					400	✓	400	✓	N/A	
					600		600		600	
					1000		1000		1000	

10083542	Merchandising Tray	<p>Merchandise your products back-of-house for an efficient way of filling Flexeserve Zone® Trays can also slot into the angled merchandising insert for improved product visibility.</p> <p>x2 Required to fill each zone shelf.</p>		<p>261mm (W) 530mm (D) 30mm (H)</p>	3 Tier		4 Tier		5 Tier	
					400		400		N/A	
					600	✓	600	✓	600	✓
					1000		1000		1000	
10082600	Merchandising Tray	<p>Merchandise your products back-of-house for an efficient way of filling Flexeserve Zone® Trays can also slot into the angled merchandising insert for improved product visibility.</p> <p>x4 Required to fill each zone shelf.</p>		<p>230mm (W) 530mm (D) 30mm (H)</p>	3 Tier		4 Tier		5 Tier	
					400		400		N/A	
					600		600		600	
					1000	✓	1000	✓	1000	✓
10080910	Merchandising Rack - Narrow	<p>Present your hash browns, pizza slices, flatbreads and more in the perfect way for visual impact, whilst at the same time increasing capacity.</p> <p>Recommended use with Merchandising Trays.</p>		<p>44mm (W) 519mm (D) 74mm (H)</p>	3 Tier		4 Tier		5 Tier	
					400	✓	400	✓	N/A	
					600	✓	600	✓	600	✓
					1000	✓	1000	✓	1000	✓
10086858	Merchandising Rack - Standard	<p>Perfect for displaying breakfast sandwiches, paninis, wraps and burritos. Double your product volume and improve visibility with one accessory.</p> <p>Recommended use with Merchandising Trays.</p>		<p>68mm (W) 520mm (D) 74mm (H)</p>	3 Tier		4 Tier		5 Tier	
					400	✓	400	✓	N/A	
					600	✓	600	✓	600	✓
					1000	✓	1000	✓	1000	✓

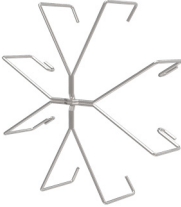
10082000	Divider	Use the handy dividers to separate different foods on the angled merchandising insert. Recommended for use with Angled Merchandising Inserts.		3mm (W) 510mm (D) 50mm (H)	3 Tier		4 Tier		5 Tier	
					400	✓	400	✓	N/A	
					600	✓	600	✓	600	✓
					1000	✓	1000	✓	1000	✓

ORDER/IBS NAME	PRODUCT DESCRIPTION	PRODUCT DESCRIPTION	VISUAL	DIMENSIONS	UNIT COMPATIBILITY							
Countertop & Free Standing Flexeserve Zone® Accessories												
10081909	Condiment Basket - Metal	The ideal way to offer impulse add-on sales of jams, honey, sauces and dressings to complement your hot products. <i>Should hang from ticket edge not riser.</i>		258mm (W) 108mm (D) 54mm (H)	2 Tier		3 Tier		4 Tier		5 Tier	
					400	✓	400	✓	400	✓	N/A	
					600	✓	600	✓	600	✓	600	✓
					1000	✓	1000	✓	1000	✓	1000	✓
30047909	Condiment Basket - Acrylic	The ideal way to offer impulse add-on sales of jams, honey, sauces and dressings to complement your hot products. <i>Should hang from riser.</i>		263mm (W) 110mm (D) 51mm (H)	2 Tier		3 Tier		4 Tier		5 Tier	
					400	✓	400	✓	400	✓	N/A	
					600	✓	600	✓	600	✓	600	✓
					1000	✓	1000	✓	1000	✓	1000	✓
30050332	Fan Guard	Protect the fan plate from being blocked by food packaging and maintain full air flow. <i>x1 Required per fan.</i>		134mm (W) 20mm (D) 134mm (H)	2 Tier		3 Tier		4 Tier		5 Tier	
					400	✓	400	✓	400	✓	N/A	
					600	✓	600	✓	600	✓	600	✓
					1000	✓	1000	✓	1000	✓	1000	✓
30048326	Flexeserve Zone® Approved Packaging Samples	Wide variety of off-the-shelf packaging samples to suit the most popular hot grab and go products.		490mm (W) 190mm (D) 360mm (H)	2 Tier		3 Tier		4 Tier		5 Tier	
					400	✓	400	✓	400	✓	N/A	
					600	✓	600	✓	600	✓	600	✓
					1000	✓	1000	✓	1000	✓	1000	✓

Night Blind

Use the night blind to close the unit down when not in use. The blind can be utilised for marketing or branding

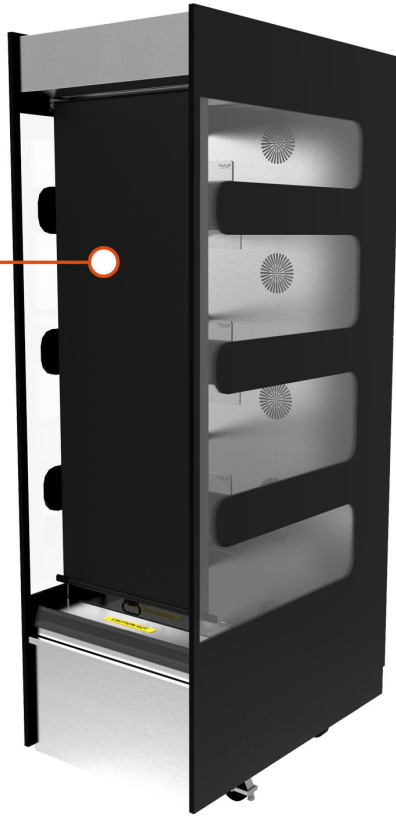

*600 4-Tier Square Zone® with back panel finishing kit fitted





*600 4-Tier Square Zone® with standard back panels fitted





Back Panel Kit

Use the back panel kit to improve the appearance of the rear of the unit in situations where it may be in view of the customer

Standard units supplied in a brush stainless steel finish with black glass end panels. For more inspiration of customisation please see the Nuttalls Flexeserve Zone® Gallery.

ORDER/IBS NAME	PRODUCT DESCRIPTION	PRODUCT DESCRIPTION	VISUAL	DIMENSIONS	UNIT COMPATIBILITY					
Countertop & Free Standing Flexeserve Zone® Accessories										
00022116 & 20106550	Zone Rear Back Panel Kit	Use the back panel kit to improve the appearance of the rear of the unit in situations where it may be in view of the customer.		322mm (W) 52mm (D) 743mm (H)	3 Tier		4 Tier		5 Tier	
					400		400	✓	N/A	
					600		600		600	
					1000		1000		1000	
00018388 & 20093873	Zone Rear Back Panel Kit	Use the back panel kit to improve the appearance of the rear of the unit in situations where it may be in view of the customer.		522mm (W) 52mm (D) 743mm (H)	3 Tier		4 Tier		5 Tier	
					400		400		N/A	
					600		600	✓	600	
					1000		1000		1000	
00018383 & 20093836	Zone Rear Back Panel Kit	Use the back panel kit to improve the appearance of the rear of the unit in situations where it may be in view of the customer.		942mm (w) 52mm (D) 743mm (H)	3 Tier		4 Tier		5 Tier	
					400		400		N/A	
					600		600		600	
					1000		1000	✓	1000	

30048599	Night Blind	Use the night blind to close the unit down when not In use. The blind can be utilised for marketing or branding.		312.5mm (W) 1300 (H)	2 Tier		3 Tier		4 Tier		5 Tier	
					400	✓	400	✓	400	✓	N/A	
					600		600		600		600	
					1000		1000		1000		1000	
30048600	Night Blind	Use the night blind to close the unit down when not In use. The blind can be utilised for marketing or branding.		525mm (W) 1300 (H)	2 Tier		3 Tier		4 Tier		5 Tier	
					400		400		400		N/A	
					600	✓	600	✓	600	✓	600	
					1000		1000		1000		1000	
30048601	Night Blind	Use the night blind to close the unit down when not In use. The blind can be utilised for marketing or branding.		945mm (W) 1300 (H)	2 Tier		3 Tier		4 Tier		5 Tier	
					400		400		400		N/A	
					600		600		600		600	
					1000	✓	1000	✓	1000	✓	1000	



Contact

For any queries relating to this information, please contact ...

[t] +44 (0) 1455 638300 [e] info@flexeserve.com [w] www.flexeserve.com

FLEXESERVE®

The Alan Nuttall Partnership Ltd, Orchard House, Dodwells Road, Hinckley, Leicestershire LE10 3BZ United Kingdom