

Star-Clean

SCP8.720

DESIGN

For many years, «Star-Clean» rotisseries have had a good reputation amongst supermarkets and in the catering industry, meeting their needs in terms of production and robustness thanks to a high output, speed and quality.

Easy to use, modern and elegant, their interior lighting will enhance the presentation of your various cooked products (poultry, large and small pieces of meat, vegetables etc ...).

Thanks to the assisted cleaning system: steam injection for softening grease + Brita softened water and high-pressure shower for stain-free cleaning + grease recovery bags placed in the mobile grease trap for disposal, «Star-Clean» will quickly become your asset in the kitchen.



SCP8.720









FEATURES

- Energy efficient
- Double glazing K-glass
- Integrated grease container with drain valve
- Digital electronic display
- Automatic preheating at start-up
- Steam program (assisted cleaning), connect to softened water
- 6 cooking programs
- Lighting with halogen lamp
- Delivered with 8 baskets (BALSC720)

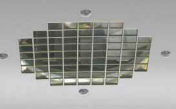





TECHNICAL DETAILS

Overview of some standard features.

	Silicone gasket for sealing the door when closed.		Retrieval and easy disposal of cooking grease with disposable bags in the mobile grease tray.		Heat diffused by turbine for a homogeneous distribution of the temperature in the cooking chamber.
	Assisted cleaning through the use of the steam injection program for softening cooking grease.		High pressure shower for precise cleaning.		Rinse without trace thanks to the use of softened water by Brita cartridge.

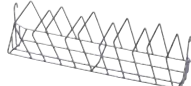
ACCESSORIES

Many accessories are available. Videos of the [accessories](#).

BALSC720 Chicken baskets.		BAB720 Big pieces of meat spit.		BCRA720 «Spatchcock chicken» baskets.	
PDSC720 Stainless steel rack top.		BPDT720 Tray for potatoes, vegetables.		CAP8.720 Grease sensor with activated charcoal filtration.	

Side view

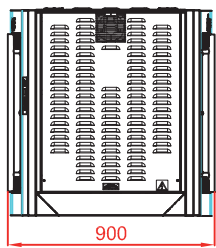

Front view

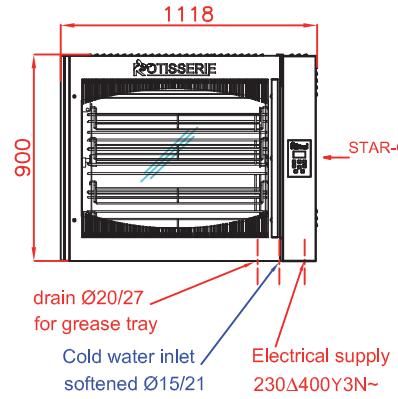

Side view

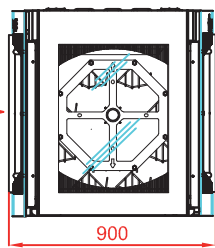

Top view

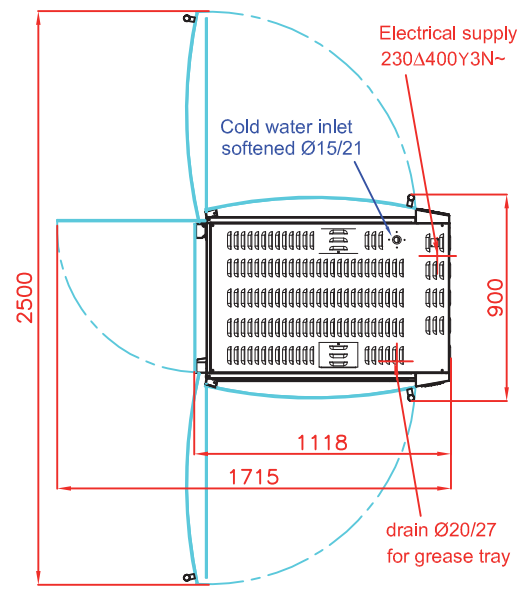

Glass protection
K.GLASS

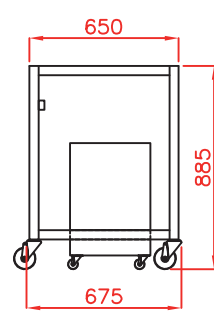
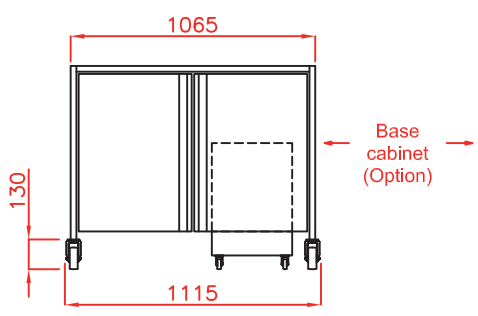

For a rinse without traces Rotisol uses water softeners and accessories by Brita

Option:
2 shelves and removable tablet

Origine / Origin Europe

Revised:
October 2020

SPECIFICATIONS

Capacity roasted chickens	32/40 poultries, 8 baskets
Capacity spatchcock chickens	28 poultries, 4 spatchcock chicken baskets
Power supply	400 V-50Hz/60Hz + earth
Electrical power	9.5 kW
Weight and size (HxDxW)*	280 kg ; 1785 x 900 x 1100 mm
Shipping weight and size*	340 kg ; 1960 x 1030 x 1230 mm
Guarantee	1 year on parts

* with a stand or base cabinet (optional)



DISTRIBUTOR / AGENT

Rotisol S.A.S.
Zone industrielle La Trentaine, Avenue Gustave Eiffel
77507 Chelles cedex - FRANCE
s.bennell@rotisol.com - Tel : +33 1 64 21 80 00
www.rotisol.com

