



### Special Market 1425.5SMG/SMiG

#### DESIGN

The Special Market range of rotisseries has been designed with performance, practicality and mobility in mind. Light weight and compact Special Market is the ideal rotisserie for markets and food trucks and offers rapid production together with excellent cooking quality.

Conscious of the costs involved for our clients, the Special Market rotisserie has energy-saving infrared burners, patented by Rotisol, that enable the rapid roasting of a variety of products.

#### FEATURES

- Energy efficient
- 2 Tempered K-glass doors (removable for transport)
- Independent motor for each spit
- Spits with Bakelite handles
- Equipped with bottom drip tray with built-in drainage
- Independent infrared gas burners with interchangeable ceramic bricks (Rotisol patented)
- Optional lighting
- Delivered with 5 prongless spits (CUI1425)
- Base on casters with brakes



1425.5SMG  
Black front panels and stainless steel finish



#### TECHNICAL DETAILS

Overview of some of the standard features.

	Replaceable ceramic bricks for significant financial savings.		Robust hinges designed for heavy use, with integrated locking in open and closed positions.		Gas safety ! separation of the gas and electric chambers avoids any risks of explosion.
	Independent floating, swinging and adjustable motors to for easy placement and removal of spits.		Anti-scald K-glass reduces external thermal radiation (energy saving). Glass overlaps drip pan to keep splatters inside (anti-slip protection).		Removable inside side-panels doubles protection from grease seeping into motors and other sensitive parts.

#### ACCESSORIES

A variety of accessories are available. See video of available [accessories](#) online.

<b>CUI1425</b> Anti-cutting prongless V-spit.		<b>PID1425</b> Tray for unspitting.		<b>BRC1425</b> Rectangular basket spit.	
<b>BS1425</b> Spit for ham / turkey.		<b>BRRO1425</b> Roast-clamp spit.		<b>BA1425</b> Lamb/suckling-pig spit.	
<b>BCR1425</b> Spatchcock chicken basket.		<b>DEC</b> Spit mover.		<b>AT</b> Gas lighter.	

### Front view

Rotisserie with roof (optional)  
and base on casters (optional)

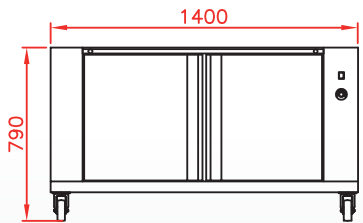
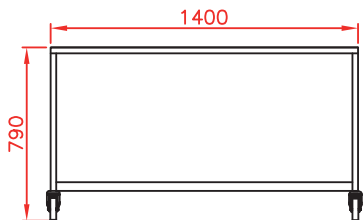
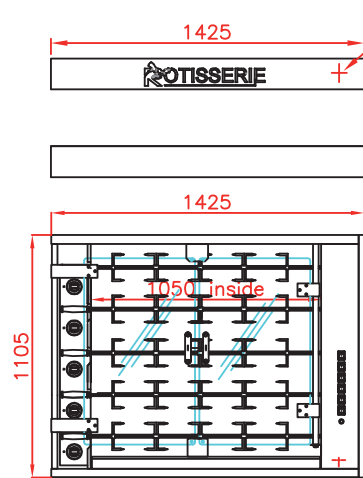

### Side view

Rotisserie with roof (optional)  
and base on casters (optional)

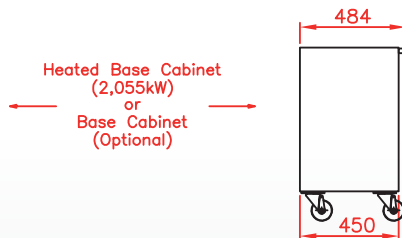
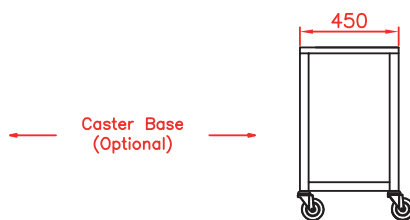
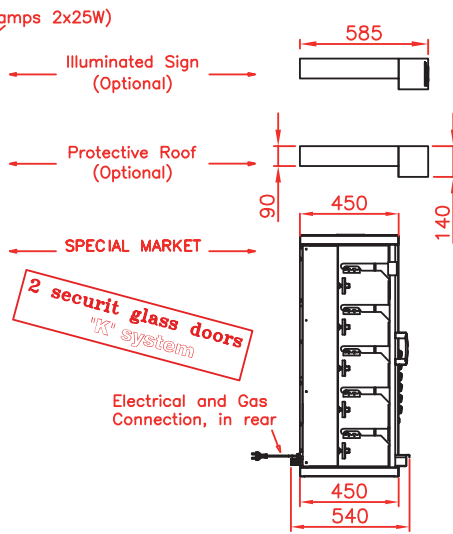

### Top view

Rotisserie with roof (optional)  
and base on casters (optional)

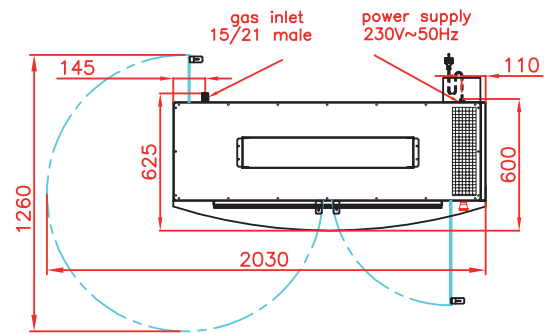

1425.5SMiG  
Stainless steel finish



Revised :  
April 2019

## SPECIFICATIONS

Capacity	25/30 poultries
Gas power	28 kW
Power supply	208-230V-50Hz/60Hz
Electrical power	0.5 kW
Weight and size (HxDxW)	150 kg ; 1985 x 625 x 1425 mm
Shipping weight and size	210 kg ; 1950 x 760 x 1450 mm
Guarantee	1 year parts



DISTRIBUTOR / AGENT

Rotisol S.A.S.

Zone industrielle La Trentaine, Avenue Gustave Eiffel

77507 Chelles cedex - FRANCE

[s.bennell@rotisol.com](mailto:s.bennell@rotisol.com) - Tel : +33 1 64 21 80 00

[www.rotisol.com](http://www.rotisol.com)