



Special Market

1175.4SMAG/SMAiG

DESIGN

The Special Market range of rotisseries has been designed with performance, practicality and mobility in mind. Light weight and compact Special Market is the ideal rotisserie for markets and food trucks and offers rapid production together with excellent cooking quality.

Conscious of the costs involved for our clients, the Special Market rotisserie has energy-saving infrared burners, patented by Rotisol, that enable the rapid roasting of a variety of products.

FEATURES

- Energy efficient
- 2 Tempered K-glass doors (removable for transport)
- Independent motor for each spit
- Spits with Bakelite handles
- Equipped with bottom drip tray with built-in drainage
- Independent infrared gas burners with interchangeable ceramic bricks (Rotisol patented)
- Optional lighting
- Delivered with 4 spits (BCR1175)
- Base on casters with brakes



1175.4SMAG

Black front panels and stainless steel finish



TECHNICAL DETAILS

Overview of some of the standard features.

	<p>Replaceable ceramic bricks for significant financial savings.</p>		<p>Robust hinges designed for heavy use, with integrated locking in open and closed positions.</p>		<p>Gas safety ! separation of the gas and electric chambers avoids any risks of explosion.</p>
	<p>Independent floating, swinging and adjustable motors to for easy placement and removal of spits.</p>		<p>Anti-scald K-glass reduces external thermal radiation (energy saving). Glass overlaps drip pan to keep splatters inside (anti-slip protection).</p>		<p>Removable inside side-panels doubles protection from grease seeping into motors and other sensitive parts.</p>

ACCESSORIES

A variety of accessories are available. See video of available [accessories](#) online.

<p>CUI1175 Anti-cutting prongless V-spit.</p>		<p>PID1175 Tray for unspitting.</p>		<p>BRC1175 Rectangular basket spit.</p>	
<p>BS1175 Spit for ham / turkey.</p>		<p>BRRO1175 Roast-clamp spit.</p>		<p>BA1175 Lamb/suckling-pig spit.</p>	
<p>BCR1175 Spatchcock chicken basket.</p>		<p>DEC Spit mover.</p>		<p>AT Gas lighter.</p>	

Front view

Rotisserie with roof (optional)
and base on casters (optional)

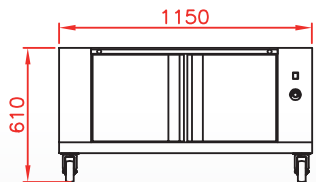
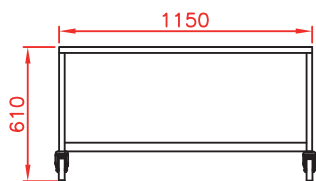
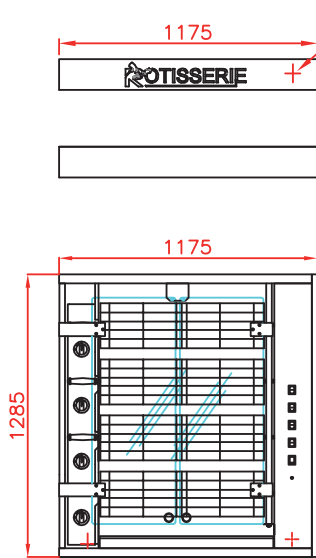

(lamps 2x25W)
Illuminated Sign
(Optional)

Protective Roof
(Optional)

SPECIAL MARKET

2 securit glass doors
"X" system

Electrical and Gas
Connection, in rear

Caster Base
(Optional)

Heated Base Cabinet
(1,055kW)
or
Base Cabinet
(Optional)

Side view

Rotisserie with roof (optional)
and base on casters (optional)

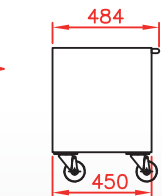
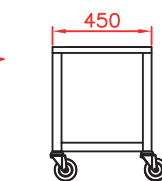
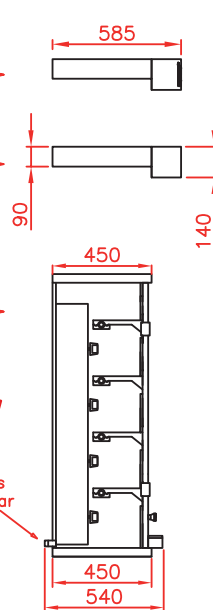

Top view

Rotisserie with roof (optional)
and base on casters (optional)

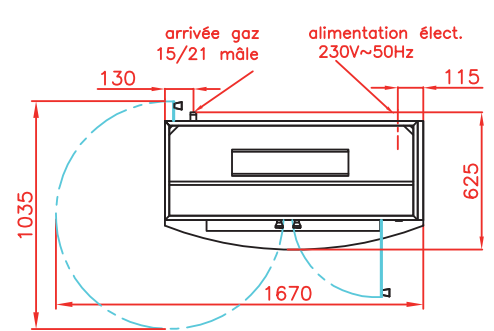

1175.4SMAiG
Stainless steel finish



Revised :
April 2019



SPECIFICATIONS

Capacity	16/20 poultries ; 12/16 open poultries
Gas power	20 kW
Power supply	208-230V-50Hz/60Hz
Electrical power	0.47 kW
Weight and size (HxDxW)	125 kg ; 1985 x 625 x 1175 mm
Shipping weight and size	175 kg ; 2000 x 760 x 1210 mm
Guarantee	1 year parts

DISTRIBUTOR / AGENT

Rotisol S.A.S.

Zone industrielle La Trentaine, Avenue Gustave Eiffel

77507 Chelles cedex - FRANCE

s.bennell@rotisol.com - Tel : +33 1 64 21 80 00

www.rotisol.com