

EXPE  
RIENCE  
LIVE STATIONS  
TABLES  
COUNTERS



# HISTORY

1946

**EN\_ Deagostini Inox was founded in 1946 in Quarna Sotto by Umberto Deagostini. Initially known as “IDEA”, it was dedicated to the production of tips made in ferrous materials in order to keep clogs and shoes intact. With the advent of the tin plate, the company began to produce the first graters with a wooden handle, until becoming, in the mid-50s, one of the first Italian manufacturers of household items intended for homes, wedding lists, bars and hotels.**

**IT\_ La Deagostini Inox fu fondata nel 1946 a Quarna Sotto da Umberto Deagostini. Inizialmente nota con il nome “IDEA”, era dedita alla produzione di puntali in materiali ferrosi al fine di mantenere intatti zoccoli e scarpe. Con l'avvento della banda stagnata iniziò a produrre le prime grattugie con manico in legno, fino a diventare, nella metà degli anni '50, una tra le prime manifatture italiane di articoli per la casa destinati ad abitazioni, liste nozze, bar ed alberghi.**

1958

**EN\_ In 1958 Umberto's son, Sandro, joined his father in running the family business. The increased production made it indispensable to inaugurate a second plant in Omegna, on the Lake of Orta and in the 80s, thanks to the economic growth, it was necessary to move to a bigger facility that could accommodate workers and machinery. The 90s marked the beginning of the production of equipments aimed at fitting out buffet for breakfast. Among the first companies to provide these tools, Deagostini took part in the creation of the buffet breakfast service, which was then consolidated especially at international luxury facilities.**

**IT\_ Nel 1958 il figlio di Umberto, Sandro, si unì al padre nella conduzione dell'azienda di famiglia. L'incremento produttivo rese indispensabile l'inaugurazione di un secondo stabilimento ad Omegna, sul lago d'Orta e negli anni '80, grazie alla crescita economica, si rese necessario il trasferimento in una struttura più grande che potesse accogliere operai e macchinari. Gli anni '90 segnarono l'inizio della produzione di attrezzature rivolte all'allestimento del buffet per la prima colazione. Tra le prime aziende a fornire questi strumenti, la Deagostini partecipò alla nascita del servizio di prima colazione a buffet, allora consolidato soprattutto presso strutture di lusso internazionali.**

2005

**EN\_ In 2005 the company started the production of Live Cooking Stations, which became today a substantial component of the company's mission. In 2009 Andrea, son of Sandro, joined the company management thus bringing Deagostini to its third generation, that combined with the link between design culture and quality of materials, enhances the “Made in Italy” in a universal dimension. Nowadays, the company counts collaborations with prestigious international facilities.**

**IT\_ Nel 2005 la compagnia intraprese il percorso della produzione di Live Cooking Stations, divenute oggi componente sostanziale della mission aziendale. Nel 2009 Andrea, figlio di Sandro, si unì alla direzione dell'azienda portando così la Deagostini alla sua terza generazione, che unita al legame tra cultura del progetto e qualità dei materiali, esalta il “Made in Italy” in una dimensione universale. Ad oggi, l'azienda annovera collaborazioni con prestigiose strutture a livello internazionale.**



Umberto Deagostini

**Umberto succeeded in transforming a post-war artisan reality into one of the first Italian manufacturers of household goods.**

*Umberto riuscì a trasformare una realtà artigianale post-guerra in una delle prime imprese italiane produttrici di casalinghi.*

**Sandro brought the company into the international reality making it, even today, a reference name in the hotel industry.**

*Sandro portò l'azienda nella realtà internazionale rendendola, ancora oggi, un nome di riferimento per il settore alberghiero.*

Sandro Deagostini



Andrea Deagostini

**Andrea, passionate about design and technology, has brought the company into the modern world with energy, passion and inventiveness.**

*Andrea, appassionato di design e tecnologia, ha portato l'azienda nel mondo moderno con energia, passione ed inventiva.*



# MISSION

Functionality, technology and design have always represented Deagostini Inox company's mission.

Funzionalità, tecnologia e design rappresentano da sempre la mission aziendale della Deagostini Inox.



## FUNCTIONALITY

EN\_ Functionality represents the necessary condition of Deagostini products. The relationship between efficiency and form, intended as aesthetics, represents an added value that gives products beauty and appeal where form is never at the expense of function, but it rather elevates its prestige.

IT\_ La funzionalità rappresenta la condizione necessaria dei prodotti Deagostini. Il rapporto tra efficienza e forma, intesa come armonia, rappresenta un valore aggiunto che conferisce ai prodotti alto valore estetico ed attrattivo dove la forma non è mai a discapito della funzione, ma anzi ne eleva il prestigio.

## DESIGN

EN\_ The diversified range of products, designed according to international standards of style, is the result of high-design choices, forerunner of new requirements and changes in contemporary living, thus giving a unique style.

IT\_ La gamma diversificata di prodotti, disegnati su impronte stilistiche internazionali, è il frutto di scelte di alto design che permettono di anticipare le nuove esigenze e i cambiamenti stilistici contemporanei, conferendo così uno stile inconfondibile.

## TECHNOLOGY

EN\_ The proximity of raw materials and local knowledge guarantee traditional languages revisited in a contemporary way, where technology always remains at the service of the design criteria. Traditional materials, such as wood and steel, blend with technology, creating beautiful environments to live, practical and durable.

IT\_ La vicinanza delle materie prime e le competenze locali garantiscono linguaggi della tradizione rivisitati in chiave contemporanea, dove la tecnologia rimane sempre al servizio dei criteri di progettazione. I materiali tradizionali, come il legno e l'acciaio, si fondono alla tecnologia creando ambienti belli da vivere, pratici e duraturi.



# MATERIALS

**EN\_ An accurate selection of materials - all of Italian and European origin, guaranteed for the food industry - is one of the secrets of the excellence of Deagostini Inox's products. The manufacturing process is carefully controlled by trained staff and is entirely conducted in our factory. In addition, our collaborations with leading European producers of appliances confirm the quality of a high standard finished product. Deagostini, thanks to its role as a manufacturer, guarantees a supplied and ready service of spare parts, in order to ensure the originality and the maximum functionality of its products, even after years of use.**

*IT\_* La scelta accurata dei materiali - tutti di origine Italiana ed Europea, garantiti per il settore alimentare - è uno dei segreti dell'eccellenza dei prodotti Deagostini Inox. Il processo produttivo è seguito scrupolosamente da personale preparato e viene interamente effettuato nei nostri stabilimenti. Inoltre, le collaborazioni con rinomati produttori europei nel settore degli elettrodomestici confermano la qualità di prodotti finiti di alto livello. La Deagostini, grazie al proprio ruolo di fabbricante, garantisce un fornito e pronto servizio di parti di ricambio, al fine di assicurare l'originalità e la massima funzionalità dei propri prodotti, anche dopo anni d'utilizzo.

*ES\_* La cuidadosa selección de materiales - todos de origen Italiano y Europeo, garantizados para la industria alimentaria - es uno de los secretos de la excelencia de los productos Deagostini Inox. El proceso de fabricación se controla cuidadosamente por personal capacitado y se hace enteramente en nuestra fábrica. Además, la colaboración con los fabricantes europeos líderes en electrodomésticos confirman la calidad de productos acabados de alto nivel. Deagostini, gracias a su papel como fabricante, garantiza un servicio suministrado y listo de piezas de repuesto para garantizar la originalidad y la máxima funcionalidad de sus productos, después de años de uso.

*FR\_* La sélection rigoureuse des matériaux - tous d'origine Italienne et Européenne, garantis pour l'industrie alimentaire - est l'un des secrets de l'excellence des produits Deagostini Inox. Le processus de fabrication est suivi scrupuleusement par du personnel formé et il est entièrement réalisé dans nos usines. Aussi, nos collaborations avec des producteurs européens renommés dans le secteur des appareils électroménagers confirment la qualité des produits finis de haut niveau. Deagostini grâce à son rôle de fabricant, garantit un service fourni et prêt de pièces de rechange, afin de garantir l'originalité et la fonctionnalité maximale de ses produits, même après des années d'utilisation.

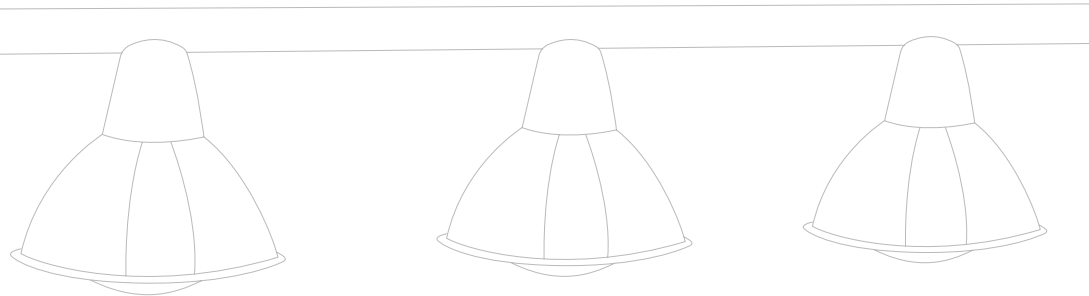

## STAINLESS STEEL 18/10-AISI 304 BRUSHED

*IT\_ Acciaio inossidabile 18/10-AISI 304 - Satinato*  
*ES\_ Acero inoxidable 18/10-AISI 304 - Satinado*  
*FR\_ Acier inoxydable 18/10-AISI 304 - Satiné*

**EN\_ Rigorous in its harmonic shapes, for a linear and functional aesthetic. In addition to its design strength, its resistance makes it a valuable, long lasting and reliable material. 100% recyclable, no maintenance, corrosion resistance and mechanical features are some of the connotations that make it an essential material.**

*IT\_* Rigoroso nelle sue forme armoniche, per un'estetica lineare e funzionale. Oltre alla sua forza progettuale, la sua resistenza lo rende un prodotto valido, duraturo e affidabile. 100% riciclabile, assenza di manutenzione, resistenza alla corrosione e caratteristiche meccaniche di rilievo sono alcune delle connotazioni che lo rendono un prodotto imprescindibile.

*ES\_* Riguroso en sus formas armoniosas, para una estética lineal y funcional. Además de su fuerza de diseño, su resistencia lo convierte en un producto válido, duradero y confiable. 100% reciclable, sin mantenimiento, resistencia a la corrosión y características mecánicas significativas son algunas de las connotaciones que lo convierten en un producto esencial.

*FR\_* Rigoureux dans ses formes harmonieuses, pour une esthétique linéaire et fonctionnelle. Sa résistance en fait un produit valide, durable et fiable. 100% recyclable, pas d'entretien, résistance à la corrosion et caractéristiques mécaniques sont des connotations qui en font un produit essentiel.



## STAINLESS STEEL 18/10-AISI 304 MIRROR FINISH

*IT\_ Acciaio inossidabile 18/10-AISI 304 - Lucidato a specchio*  
*ES\_ Acero inoxidable 18/10-AISI 304 - Acabado espejo*  
*FR\_ Acier inoxydable 18/10-AISI 304 - Poli miroir*

**EN\_ 100% recyclable, long lasting and with mechanical features that ensure lack of maintenance, corrosion resistance and sustainability. Bright finishes make details accurate and distinctive.**

*IT\_* 100% riciclabile, duraturo e con caratteristiche meccaniche di rilievo che garantiscono assenza di manutenzione, resistenza alla corrosione e durezza. Le finiture brillanti rendono i dettagli accurati e distintivi.

*ES\_* 100% reciclable, duradero y con características mecánicas de alivio que aseguran el mantenimiento, la resistencia a la corrosión y la durabilidad. Los brillantes acabados hacen que los detalles sean precisos y distintivos.

*FR\_* 100% recyclable, durable et avec des caractéristiques mécaniques de relief qui assurent aucun entretien, résistance à la corrosion et durabilité. Les finitions brillantes rendent les détails précis et distinctifs.

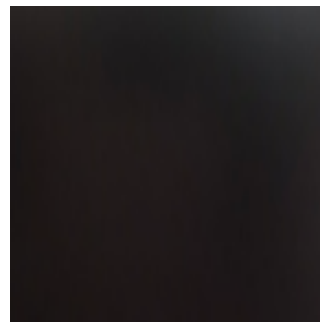

## WOOD

WALNUT NATURAL COLOR / BLACK COLOR

*IT\_ Legno – Tinta noce naturale/Tinta nera*

*ES\_ Madera – Color natural de nogal/Color negro*

*FR\_ Bois – Couleur noyer naturel/Couleur noir*

**EN\_ Warm and cozy, it creates a sophisticated game of references between the past and the present, tradition and innovation. Marked by high value and natural finishes. Strong, compact, long lasting and easy to clean. It is the distinctive feature of every project.**

*IT\_ Caldo e accogliente, crea un sofisticato gioco di rimandi tra passato e presente, tradizione ed innovazione. Di grande pregio e dalle finiture naturali. Robusto, compatto, longevo e di facile pulizia. Rappresenta un segno distintivo ed estremamente caratterizzante di ogni progetto.*

*ES\_ Cálido y acogedor, crea un sofisticado juego de referencias entre el pasado y el presente, la tradición y la innovación. De gran valor y acabados naturales. Robusto, compacto, duradero y fácil de limpiar. Representa un signo distintivo y extremadamente característico de cada proyecto.*

*FR\_ Chaleureux et accueillant, crée un jeu sophistiqué de références entre passé et présent, tradition et innovation. De grand valeur et avec finitions naturelles. Robuste, compact, durable et facile à nettoyer. Il représente un signe fort et caractéristique de chaque projet.*

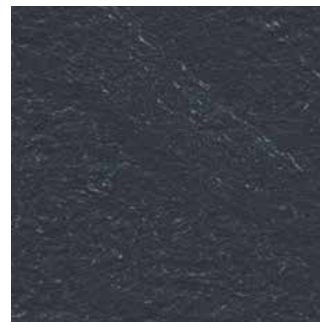

## HIGH PRESSURE LAMINATE

LAYERED

*IT\_ Laminato ad alta pressione – Multistrato*

*ES\_ Laminado de alta presión – Multicapas*

*FR\_ Stratifié haute pression – Multicouche*

**EN\_ Revolution and innovation in an excellent material thanks to its functional and aesthetic potentialities. Anti-scratch, waterproof, resistant to oils, steam and water. Unalterable up to 60°, anti bacterial and long lasting.**

*IT\_ Rivoluzione ed innovazione in un materiale eccellente per le sue potenzialità funzionali ed estetiche. Anti-graffio, impermeabile, resiste ad oli, vapore ed acqua. Inalterabile fino a 60°, anti batterico e duraturo.*

*ES\_ Revolución e innovación en un material excelente por sus potencialidades funcionales y estéticas. Anti-rasguños, impermeable, resistente a aceites, vapor y agua. Inalterable hasta 60°, antibacteriano y de larga duración.*

*FR\_ Révolution et innovation dans un excellent matériau pour ses potentialités fonctionnelles et esthétiques. Anti-rayures, imperméable, résistant aux huiles, à la vapeur et à l'eau. Inaltérable jusqu'à 60°, anti bactérien et durable.*



## POLYCARBONATE

*IT\_ Policarbonato*

*ES\_ Policarbonato*

*FR\_ Polycarbonate*

**EN\_ Extremely versatile, excellent for the creation of functional and aesthetically pleasing long lasting products. Recyclability, resistance, heat and shape stability make it one of the most required thermoplastic materials for new applications.**

*IT\_ Estremamente versatile, eccellente per la creazione di prodotti funzionali ed esteticamente piacevoli, nonché durevole nel tempo. Riciclabilità, resistenza, stabilità termica e dimensionale lo rendono uno dei materiali termoplastici maggiormente richiesti per le nuove applicazioni.*

*ES\_ Extremadamente versátil, excelente para la creación de productos funcionales, estéticamente agradables y duradero. Reciclabilidad, resistencia, estabilidad térmica y dimensional lo convierten en uno de los materiales termoplásticos más populares para las nuevas aplicaciones.*

*FR\_ Polyvalent, excellent pour la création des produits fonctionnels et esthétiques, durable. Recyclabilité, résistance, stabilité thermique et dimensionnelle en font un des produits thermoplastiques les plus populaire pour les nouvelles applications.*



## TEMPERED GLASS

*IT\_ Vetro temperato*

*ES\_ Vidrio templado*

*FR\_ Verre trempé*

**EN\_ Pure and shiny, healthy and eco-friendly. Easy to clean and abrasion resistant. The charm of this precious material lies in its ability to show and separate, to contain and reveal at the same time.**

*IT\_ Puro e luminoso, sano ed ecosostenibile. Di facile pulizia e resistente alle abrasioni. Il fascino di questo prezioso minerale risiede nella sua capacità di mostrare e separare, di contenere e rivelare allo stesso tempo.*

*ES\_ Puro y brillante, saludable y eco-sostenible. Fácil de limpiar y resistente a la abrasión. El encanto de este mineral precioso reside en su capacidad de mostrar y separar, de contener y revelar al mismo tiempo.*

*FR\_ Pur et lumineux, sain et écordable. Facile à nettoyer et résistant à l'abrasion. Le charme de ce précieux matériel est la capacité à montrer et séparer, à contenir et à révéler en même temps.*

# LOCATION

**EN\_** Our company is located in Omegna (VB), 50 Km from Switzerland and 100 Km from Milan.

**IT\_** La nostra azienda si trova ad Omegna (VB), a 50 Km dalla Svizzera e a 100 Km da Milano.

**ES\_** Nuestra empresa se encuentra en Omegna (VB), a 50 Km de Suiza y 100 Km de Milán.

**FR\_** Notre entreprise se trouve à Omegna (VB), à 50 Km de la Suisse et a 100 Km de Milan.



# KEY

 **Refrigerated by cooling pack**  
Raffreddamento con piastra eutettica  
Refrigerado por acumulador térmico  
Refrondissement avec pain de glace

 **Electric resistance feeding**  
Alimentazione con resistenza elettrica  
Alimentación con resistencia eléctrica  
Alimentation avec résistance électrique

 **Customizable item**  
Articolo realizzabile su misura  
Artículo realizable por encargo  
Article réalisable sur mesure

 **GN 2/3** GN 2/3

 **Recyclable material**  
Materiale riciclabile  
Material reciclable  
Matériau recyclable

 **Refrigerated by ice cubes**  
Raffreddamento con cubetti di ghiaccio  
Refrigerado por cubitos de hielo  
Refrondissement avec glaçons

 **Electric current feeding**  
Alimentazione a corrente elettrica  
Alimentación a corriente  
Alimentation électrique

 **Grid for drain**  
Griglia per drenaggio  
Parilla por drenaje  
Grille pour drainage

 **GN 6/1** GN 6/1

 **Suitable for food contact**  
Adatto al contatto con gli alimenti  
Adapto para contacto alimentario  
Convenient au contact alimentaire

 **Refrigerated**  
Refrigerato  
Refrigerado  
Réfrigéré

 **Bain marie**  
Bagno maria  
Baño maria  
Bain-marie

 **Adjustable clutch**  
Frizione regolabile  
Fricción regulable  
Friction réglable

 **Gas bottle**  
Bombola gas  
Cilindro de gas  
Bouteille de gaz

 **CE**

 **Spout**  
Rubinetto di scarico  
Grifo de descarga  
Robinet de vidange

 **Induction feeding**  
Alimentazione a induzione  
Alimentación con inducción  
Alimentation avec induction

 **GN 1/1** GN 1/1

 **Gas feeding**  
Alimentazione a gas  
Alimentación con gas  
Alimentation à gaz

 **MADE IN ITALY**



# INDEX



## TABLES

PAG. 16

breakfast.....	22
cook & self service ...	42
neo .....	50
star .....	54
moon.....	58
smart.....	66
domino .....	70



## LIVE COOKING & COCKTAIL STATIONS

PAG. 112

evolution .....	120
showcooking.....	134
cube .....	146
new cube .....	154
naked.....	170



## COUNTERS

PAG. 74

tetris .....	82
idea .....	94
double .....	102



## CAST IRON COCOTTES

PAG. 190



# tables

A complete range of buffet equipments on compatible and modular tables, that can be placed side by side and equipped in infinite combinations to meet the needs of fixed and mobile catering.

A modern and professional banqueting and foodservice system: functional, technological and of design.

*IT\_* Una gamma completa di apparecchiature da buffet su tavoli compatibili e modulari, che possono essere affiancati e attrezzati in infinite combinazioni per soddisfare le esigenze della ristorazione fissa e mobile.

Un moderno e professionale sistema di banqueting e foodservice: funzionale, tecnologico e di design.

*ES\_* Una gama completa de equipos de buffet mesas compatibles y modulares, que pueden colocarse una al lado de la otra y equipadas en infinitas combinaciones para satisfacer las necesidades de la restauración fija y móvil.

Un moderno y profesional sistema de banquetes y servicios gastronómicos: funcional, tecnológico y de design.

*FR\_* Une gamme complète d'équipements de buffet sur tables compatibles et modulaires, qui peuvent être placés côte à côte et équipés dans une infinité de combinaisons pour répondre aux besoins de la restauration fixe et mobile.

Un système de réception et de restauration moderne et professionnel: fonctionnel, technologique et du conception.





## Functionality, Technology and Design.



### High pressure laminate - Layered

*IT\_* Laminato ad alta pressione - Multistrato  
*ES\_* Laminado de alta presión - Multicapas  
*FR\_* Stratifié haute pression - Multicouche

**EN\_ Revolution and innovation in an excellent material thanks to its functional and aesthetic potentialities. Anti-scratch, waterproof, resistant to oils, steam and water. Unalterable up to 60°, anti bacterial and long lasting.**

*IT\_* Rivoluzione ed innovazione in un materiale eccellente per le sue potenzialità funzionali ed estetiche. Anti-graffio, impermeabile, resiste ad oli, vapore ed acqua. Inalterabile fino a 60°, anti batterico e duraturo.

*ES\_* Revolución e innovación en un material excelente por sus potencialidades funcionales y estéticas. Anti-rasguños, impermeable, resistente a aceites, vapor y agua. Inalterable hasta 60°, antibacteriano y de larga duración.

*FR\_* Révolution et innovation dans un excellent matériau pour ses potentialités fonctionnelles et esthétiques. Anti-rayures, imperméable, résistant aux huiles, à la vapeur et à l'eau. Inaltérable jusqu'à 60°, anti bactérien et durable.

**EN\_ A supporting structure only partially embedded in the surface of the table, to ensure stability and flow, without neglecting the elegance guaranteed by the mirror-polished stainless steel.**

*IT\_* Una struttura portante solo parzialmente incassata nella superficie del tavolo, per assicurare stabilità e portata, senza trascurare l'eleganza garantita dall'acciaio inossidabile lucidato a specchio.

*ES\_* Una estructura de soporte solo parcialmente incrustada en la superficie de la mesa, para garantizar la estabilidad y el flujo, sin descuidar la elegancia garantizada por el acero inoxidable acabado espejo.

*FR\_* Une structure de support seul partiellement encastrée dans la surface du table, pour assurer la stabilité et la fluidité, sans pour autant négliger l'élégance garantie par l'acier inoxydable poli miroir.

### Stainless steel 18/10-AISI 304 Mirror finish

*IT\_* Acciaio inossidabile 18/10-AISI 304 - Lucidato a specchio  
*ES\_* Acero inoxidable 18/10-AISI 304 - Acabado espejo  
*FR\_* Acier inoxydable 18/10-AISI 304 - Poli miroir

**EN\_ 100% recyclable, long lasting and with mechanical features that ensure lack of maintenance, corrosion resistance and sustainability. Bright finishes make details accurate and distinctive.**

*IT\_* 100% riciclabile, duraturo e con caratteristiche meccaniche di rilievo che garantiscono assenza di manutenzione, resistenza alla corrosione e durevolezza. Le finiture brillanti rendono i dettagli accurati e distintivi.

*ES\_* 100% reciclable, duradero y con características mecánicas de alivio que aseguran el mantenimiento, la resistencia a la corrosión y la durabilidad. Los brillantes acabados hacen que los detalles sean precisos y distintivos.

*FR\_* 100% recyclable, durable et avec des caractéristiques mécaniques de relief qui assurent aucun entretien, résistance à la corrosion et durabilité. Les finitions brillantes rendent les détails précis et distinctifs.

## Breakfast / Cook / Self service



**1 Made of poplar wood covered with 9/10 high pressure laminate.**

*IT\_* Realizzati in legno di pioppo rivestito da laminato ad alta pressione da 9/10.

*ES\_* Hecho en madera de álamo revestido de laminado de alta presión de 9/10.

*FR\_* Fabriqués en bois de peuplier recouvert en stratifié haute pression de 9/10.

**2 Structure made in 18/10-AISI 304 mirror finish stainless steel.**

*IT\_* Struttura realizzata in acciaio inossidabile 18/10-AISI 304 lucidato a specchio.

*ES\_* Estructura hecha en acero inoxidable 18/10-AISI 304 acabado espejo.

*FR\_* Structure réalisée en acier inoxydable 18/10-AISI 304 poli miroir.

**3 Equipped with 4 pivoting, nonmarking wheels with brakes, to facilitate service maneuvers and storage.**

*IT\_* Muniti di 4 ruote pivotanti, antitraccia e dotate di freno, per facilitare la manovre di servizio e stoccaggio.

*ES\_* Equipado con 4 ruedas rotatorias, antihuella y provista de frenos, para facilitar las maniobras de servicio y almacenamiento.

*FR\_* Equipé de 4 roues pivotantes, non marquantes avec freins, pour faciliter les manœuvres d'entretien et stockage.



**Tables can be customized with a wide range of colours available.**

*IT\_* I tavoli possono essere personalizzati con una vasta gamma di colori disponibili.

*ES\_* Las mesas se pueden personalizar con una amplia gama de colores disponibles.

*FR\_* Les tables peuvent être personnalisées avec une large gamme de couleurs disponibles.

finishes

**MATT**

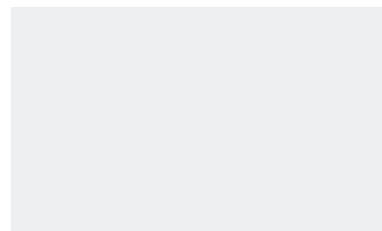

**W1**  
white ice

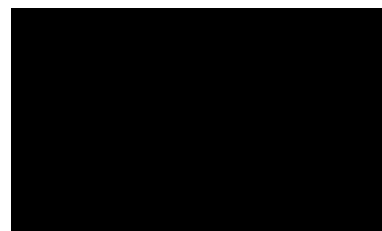

**B1**  
black



**C2**  
walkprint

**CLIMB**

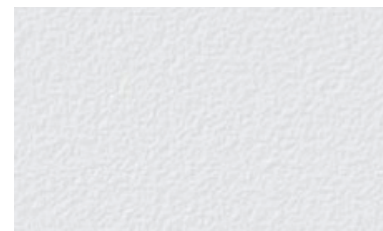

**W5**  
white climb

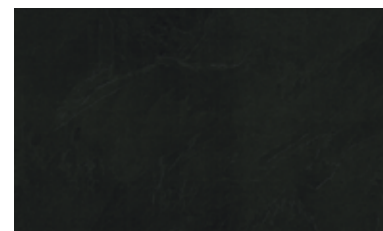

**B2**  
black ardesia



**C1**  
greige

**MOD ULTRA MATT**

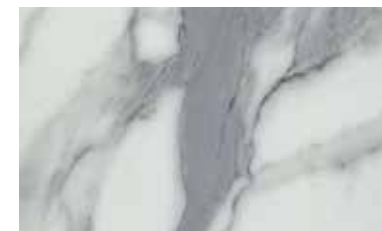

**W2**  
calacatta

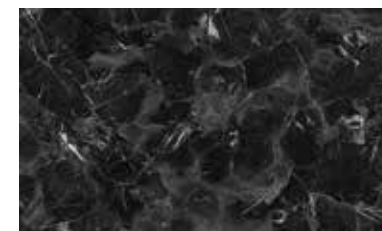

**B6**  
impero



**C7**  
navajo

Customization of all tables on request. Contact our sales office.

**Some examples**

**We propose, here following, some examples of customization that can be applied to tables.**

*IT\_* Proponiamo a seguire alcuni esempi di personalizzazione che possono essere applicati ai tavoli.

*ES\_* Proponemos a seguir algunos ejemplos de personalización que se pueden aplicar a las mesas.

*FR\_* Nous vous proposons de suivre quelques exemples de personnalisation qui pouvant être appliqués aux tables.

*EN\_* Deagostini Inox offers its customers a personalized design service.

**Contact our sales office and request a customized proposal regarding products, finishes, colours and technical equipment.**

**The technical office is at your disposal to combine our range of proposals based on your needs!**

*IT\_* La Deagostini Inox offre ai propri clienti un servizio di progettazione personalizzato.

Contatta il nostro ufficio vendite e richiedi una proposta su misura in merito a prodotti, finiture, colori e attrezzature tecniche.

L'ufficio tecnico è a tua disposizione per combinare la nostra gamma di proposte in base alle tue esigenze!

*ES\_* Deagostini Inox ofrece a sus clientes un servicio de design personalizado.

Póngase en contacto con nuestra oficina de ventas y solicite una propuesta personalizada en cuanto a productos, acabados, colores y equipos técnicos.

La oficina técnica está a su disposición para combinar nuestra gama de propuestas según sus necesidades!

*FR\_* Deagostini Inox propose à ses clients un service de design sur mesure.

Contactez notre bureau des ventes et demandez une proposition personnalisée concernant les produits, les finitions, les couleurs et les équipements techniques.

Le bureau technique est à votre disposition pour combiner notre gamme de propositions en fonction de vos besoins!





# breakfast



**Basic models are available in three different sizes and can be used neutral or equipped with a wide range of appliances and optional.**

*IT\_* I modelli base sono disponibili in tre differenti misure e possono essere utilizzati neutri oppure equipaggiati con una vasta gamma di applicazioni ed optional.  
*ES\_* Los modelos básicos están disponibles en tres tamaños diferentes y pueden utilizarse de manera neutral o equipados con una amplia gama de aplicaciones y opcionales.  
*FR\_* Les modèles de base sont disponibles en trois tailles différentes et peuvent être utilisés neutres ou équipés d'un large éventail d'applications et d'optionals.



## Table sizes

ART. BREAKFAST 160  
cm 160x80x(h)82

ART. BREAKFAST 210  
cm 210x80x(h)82

ART. BREAKFAST 250  
cm 250x80x(h)82

**Polycarbonate protection.**

*IT\_* Protezione in policarbonato.  
*ES\_* Protección en policarbonato.  
*FR\_* Protection en polycarbonate.

SIZE: cm 206 - h cm 55



ART. BREAKFAST 210/B2/X1  
 cm 210x80x(h)82+55



ART. BREAKFAST 250/B2/X1  
 cm 250x80x(h)82+55

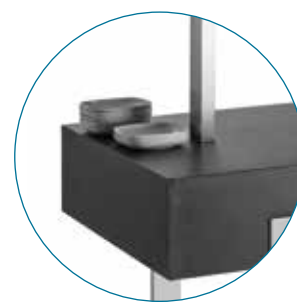

**Tabletop for plates on both sides.**

*IT\_* Piano d'appoggio per piatti su ambo i lati.  
*ES\_* Llano de apoyo para platos en ambos lados.  
*FR\_* Dessus de table pour assiettes des deux côtés.



**ART. X1**

**EN\_ Neutral polycarbonate protection.**  
*IT\_* Protezione neutra in policarbonato.  
*ES\_* Protección neutra de policarbonato.  
*FR\_* Protection neutre en polycarbonate.

**ART. Y1**

**EN\_ Polycarbonate protection with LED lighting.**  
*IT\_* Protezione in policarbonato con illuminazione LED.  
*ES\_* Protección de policarbonato con iluminación LED.  
*FR\_* Protection en polycarbonate avec éclairage LED.

**ART. Z1**

**EN\_ Polycarbonate protection with heating lamp.**  
**Only to be combined with appliance Art. HOT53.**  
*IT\_* Protezione in policarbonato con lampada riscaldante.  
 Abbinabile solo all'applicazione Art. HOT 53.  
*ES\_* Protección de policarbonato con lámpara de calentamiento.  
 Para ser combinado solo con l'applicacion Art. HOT53.  
*FR\_* Protection en polycarbonate avec lampe chauffante.  
 Combinable seulement avec l'application Art. HOT53.

See page 40.



**Tempered glass protection and plates holder.**

*IT\_* Protezione e appoggio per piatti in vetro temperato.

*ES\_* Protección y soporte de platos de vidrio templado.

*FR\_* Protection et porte-assiettes en verre trempé.

SIZE: cm 206 - h cm 50



ART. BREAKFAST 210/B2/X2  
cm 210x80x(h)82+50



ART. BREAKFAST 250/B2/X2  
cm 250x80x(h)82+50



**ART. X2**

**EN\_ Neutral tempered glass protection and plates holder.**

*IT\_* Protezione e appoggio per piatti neutro in vetro temperato.

*ES\_* Protección y soporte de platos neutro de vidrio templado.

*FR\_* Protection et porte-assiettes neutre en verre trempé.



**ART. Y2**

**EN\_ Tempered glass protection and plates holder with LED lighting.**

*IT\_* Protezione e appoggio per piatti in vetro temperato con illuminazione LED.

*ES\_* Protección y soporte de platos de vidrio templado con iluminación LED.

*FR\_* Protection et porte-assiettes en verre trempé avec éclairage LED.

## Some examples



ART. BREAKFAST 210/B2/HOT53/X1



ART. BREAKFAST 250/B2/HOT53/X1



ART. BREAKFAST 210/B2/HOT53

### Table equipped with 18/10-AISI 304 stainless steel heating plate.

Adjustable temperature from +30 to +90°C.  
6 GN 1/1 - cm 194x52 - 200W - 230V - 50/60Hz.



*IT\_* Tavolo equipaggiato con piano caldo in acciaio inossidabile 18/10-AISI 304.  
*ES\_* Mesa equipada con placa calentadora en acero inoxidable 18/10-AISI 304.  
*FR\_* Table équipé du plateau chauffante en acier inoxydable 18/10-AISI 304.

colours available	matt finish	W1	B1	C2
	climb finish	W5	B2	C1
	ultra matt finish	W2	B6	C7

#### Optional

**Neutral polycarbonate protection.**

*IT\_* Protezione neutra in polycarbonato.

*ES\_* Protección neutra de polycarbonato.

*FR\_* Protection neutre en polycarbonate.

## Some examples



ART. BREAKFAST 210/B2/COL56/X1



ART. BREAKFAST 250/B2/COL56/X1



ART. BREAKFAST 210/B2/COL56

**Table equipped with refrigerated  
18/10-AISI 304 stainless steel basin.**  
Adjustable temperature from -5 to +8°C.  
6 GN 1/1 - cm 205x63 - 256W - 220V - 50Hz.



*IT\_* Tavolo equipaggiato con vasca refrigerata in acciaio inossidabile 18/10-AISI 304.

*ES\_* Mesa equipada con cubeta refrigerada de acero inoxidable 18/10-AISI 304.

*FR\_* Table équipé de bac réfrigérée en acier inoxydable 18/10-AISI 304.

colours available	matt finish	W1	B1	C2
	climb finish	W5	B2	C1
	ultra matt finish	W2	B6	C7

### Optional

**Neutral polycarbonate protection.**

*IT\_* Protezione neutra in polycarbonato.

*ES\_* Protección neutra de polycarbonato.

*FR\_* Protection neutre en polycarbonate.



## Some examples



ART. BREAKFAST 210/B2/COL55/HOT52/X1



ART. BREAKFAST 250/B2/COL55/HOT52/X1

colours available	finish	W1	B1	C2
	matt finish	W1	B1	C2
	climb finish	W5	B2	C1
	ultra matt finish	W2	B6	C7

### Optional

#### Neutral polycarbonate protection.

IT\_ Protezione neutra in polycarbonato.

ES\_ Protección neutra de polycarbonato.

FR\_ Protection neutre en polycarbonate.

## Table equipped with refrigerated 18/10-AISI 304 stainless steel basin and heating plate.



EN\_ Refrigerated 18/10-AISI 304 stainless steel basin.  
3 GN 1/1 - cm 106x62 - 350W.

IT\_ Vasca refrigerata in acciaio inossidabile 18/10-AISI 304.

ES\_ Cubeta refrigerada de acero inoxidable 18/10-AISI 304.

FR\_ Bac réfrigérée en acier inoxydable 18/10-AISI 304.

IT\_ Tavolo equipaggiato con vasca refrigerata e piano caldo in acciaio inossidabile.

ES\_ Mesa equipada con cubeta refrigerada y placa calentadora en acero inoxidable.

FR\_ Table équipée de bac réfrigérée et plateau chauffante en acier inoxydable.



EN\_ 18/10-AISI 304 stainless steel heating plate.  
Adjustable temperature from +30 to +90°C.  
2 GN 1/1 - cm 69x62 - 600W - 230V - 50/60Hz.

IT\_ Piano caldo in acciaio inossidabile 18/10-AISI 304.

ES\_ Placa calentadora en acero inoxidable 18/10-AISI 304.

FR\_ Plateau chauffante en acier inoxydable 18/10-AISI 304.



ART. BREAKFAST 210/B2/COL55/HOT52

### Some examples



ART. BREAKFAST 250/B2/IND51/X1

### Table equipped with induction glass-ceramic tabletop heat-retaining unit.

cm 80x40 - 230V - 1,5kW.



*IT\_* Tavolo equipaggiato con unità di mantenimento del calore ad induzione in vetroceramica.

*ES\_* Mesa equipada con unidad de calentamiento por inducción en vidrio cerámica.

*FR\_* Table équipée d'unité de chauffage par induction en vitrocéramique.



ART. BREAKFAST 210/B2/IND51

colours available	matt finish	W1	B1	C2
	climb finish	W5	B2	C1
	ultra matt finish	W2	B6	C7

#### Optional

#### Neutral polycarbonate protection.

*IT\_* Protezione neutra in policarbonato.

*ES\_* Protección neutra de policarbonato.

*FR\_* Protection neutre en polycarbonate.

### Some examples



ART. BREAKFAST 210/B2/IND51/IND51/X1

### Table equipped with two induction glass-ceramic tabletop heat-retaining unit.

2x cm 80x40 - 230V - 1,5kW.



*IT\_* Tavolo equipaggiato con due unità di mantenimento del calore ad induzione in vetroceramica.

*ES\_* Mesa equipada con dos unidades de calentamiento por inducción en vidrio cerámica.

*FR\_* Table équipée de deux unités de chauffage par induction en vitrocéramique.



ART. BREAKFAST 210/B2/IND51/IND51

colours available	matt finish	W1	B1	C2
	climb finish	W5	B2	C1
	ultra matt finish	W2	B6	C7

#### Optional

#### Neutral polycarbonate protection.

*IT\_* Protezione neutra in policarbonato.

*ES\_* Protección neutra de policarbonato.

*FR\_* Protection neutre en polycarbonate.

## Some examples

### Table equipped with two refrigerated glass-ceramic tabletop.

Adjustable temperature from -5 to +15°C.  
2x 2 GN 1/1 - cm 53x66 - 170W - 50/60Hz.



*IT\_* Tavolo equipaggiato con due piani refrigerati in vetroceramica.  
*ES\_* Mesa equipada con dos tapas refrigerada de vidrio cerámica.  
*FR\_* Table équipé de deux plateau réfrigéré en vitrocéramique.



ART. BREAKFAST 210/B2/COL54/COL54/X1

colours available	matt finish	W1	B1	C2
	climb finish	W5	B2	C1
	ultra matt finish	W2	B6	C7

#### Optional

#### Neutral polycarbonate protection.

*IT\_* Protezione neutra in polycarbonato.

*ES\_* Protección neutra de polycarbonato.

*FR\_* Protection neutre en polycarbonato.

## Some examples

### Table equipped with tabletop heat-retaining unit and refrigerated glass-ceramic top.



ART. BREAKFAST 250/B2/IND51/COL54/X2



#### *EN\_* Induction glass-ceramic tabletop heat-retaining unit.

*IT\_* Unità di mantenimento del calore ad induzione in vetroceramica.

*ES\_* Unidad de mantenimiento de calor por inducción de vitrocéramica.

*FR\_* Unité de chauffage par induction en vitrocéramique.

cm 80x40 - 230V - 1,5kW

*IT\_* Tavolo equipaggiato con unità di mantenimento del calore ad induzione in vetroceramica e piano refrigerato in vetroceramica.  
*ES\_* Mesa equipada de unidad de retención de calor y tapa refrigerada de vidrio cerámica.  
*FR\_* Table équipé d'unité de rétention de chaleur et plateau réfrigéré en vitrocéramique.



#### *EN\_* Refrigerated glass-ceramic top. Adjustable temperature from -5 to +15°C.

*IT\_* Piano refrigerato in vetroceramica.

*ES\_* Tapa refrigerada de vitrocéramica.

*FR\_* Plateau réfrigéré en vitrocéramique.

2 GN 1/1 - cm 53x66 - 170W - 50/60Hz.

colours available	matt finish	W1	B1	C2
	climb finish	W5	B2	C1
	ultra matt finish	W2	B6	C7

#### Optional

#### Neutral tempered glass protection.

*IT\_* Protezione neutra in vetro temperato.

*ES\_* Protección neutra de vidrio templado.

*FR\_* Protection neutre en verre trempé.



### Some examples

#### Table equipped with induction glass-ceramic tabletop heat-retaining unit. 2x cm 32x32 - 2x cm 52x32 - 230V - 3,2kW.



*IT\_* Tavolo equipaggiato con unità di mantenimento del calore ad induzione in vetroceramica.  
*ES\_* Mesa equipada con unidad de mantenimiento del calor por inducción de vitrocerámica.  
*FR\_* Table équipée d'unité de chauffage par induction en vitrocéramique.



ART. BREAKFAST 210/B2/IND50/X1



ART. BREAKFAST 210/B2/IND50

colours available	matt finish	W1	B1	C2
	climb finish	W5	B2	C1
	ultra matt finish	W2	B6	C7

#### Optional

**Neutral polycarbonate protection.**

*IT\_* Protezione neutra in polycarbonato.

*ES\_* Protección neutra de polycarbonato.

*FR\_* Protection neutre en polycarbonate.

### Some examples

#### Table equipped with two 18/10-AISI 304 stainless steel ice basins.

2 GN 1/1 - cm 41x62 - depth cm 10,9.  
 3 GN 1/1 - cm 106x62 - depth cm 10,9.







ART. BREAKFAST 210/B2/ICE57/ICE58



*IT\_* Tavolo equipaggiato di due vasche per ghiaccio in acciaio inossidabile 18/10-AISI 304.  
*ES\_* Mesa equipada de dos cubetas para hielo en acero inoxidable 18/10-AISI 304.  
*FR\_* Table équipé de deux bacs à glace en acier inoxydable 18/10-AISI 304.



colours available	matt finish	W1	B1	C2
	climb finish	W5	B2	C1
	ultra matt finish	W2	B6	C7



Appliances available:

HOT MAINTENANCE APPLIANCES	Appliances	Code	Description				Technical info	cm 160x80x(h)82	cm 210x80x(h)82	cm 250x80x(h)82
		IND50	<b>EN_</b> Induction glass-ceramic tabletop heat-retaining unit. Remote control.	<b>IT_</b> Unità di mantenimento del calore ad induzione in vitroceramica. Comando remoto.	<b>ES_</b> Unidad de mantenimiento de calor por inducción de vitrocerámica. Comando a distancia.	<b>FR_</b> Unité de chauffage par induction en vitrocéramique. Commande à distance.	2x cm 32x32 2x cm 52x32  230V - 3,2kW			
	IND51	<b>EN_</b> Induction glass-ceramic tabletop heat retaining unit. Remote control.	<b>IT_</b> Unità di mantenimento del calore ad induzione in vitroceramica. Comando remoto.	<b>ES_</b> Unidad de mantenimiento de calor por inducción de vitrocerámica. Comando a distancia.	<b>FR_</b> Unité de chauffage par induction en vitrocéramique. Commande à distance.	cm 80x40  230V - 1,5kW				
	HOT52	<b>EN_</b> 18/10-AISI 304 stainless steel heating plate. Adjustable temperature from +30 to +90°C. Remote control.	<b>IT_</b> Piano caldo in acciaio inossidabile 18/10-AISI 304. Temperatura regolabile da +30 a +90°C. Comando remoto.	<b>ES_</b> Placa calentadora en acero inoxidable 18/10-AISI 304. Temperatura regulable de +30 a +90°C. Comando a distancia.	<b>FR_</b> Plateau chauffante en acier inoxydable 18/10-AISI 304. Température réglable de +30 à +90°C. Commande à distance.	2 GN 1/1 cm 69x62  600W - 230V - 50/60Hz				
	HOT53	<b>EN_</b> 18/10-AISI 304 stainless steel heating plate. Adjustable temperature from +30 to +90°C. Remote control.	<b>IT_</b> Piano caldo in acciaio inossidabile 18/10-AISI 304. Temperatura regolabile da +30 a +90°C. Comando remoto.	<b>ES_</b> Placa calentadora en acero inoxidable 18/10-AISI 304. Temperatura regulable de +30 a +90°C. Comando a distancia.	<b>FR_</b> Plateau chauffante en acier inoxydable 18/10-AISI 304. Température réglable de +30 à +90°C. Commande à distance.	6 GN 1/1 cm 194x52  200W - 230V - 50/60Hz				

COLD MAINTENANCE APPLIANCES	Appliances	Code	Description				Technical info	cm 160x80x(h)82	cm 210x80x(h)82	cm 250x80x(h)82
		COL54	<b>EN_</b> Refrigerated glass-ceramic tabletop. Adjustable temperature from -5 to +15°C. Remote control.	<b>IT_</b> Piano refrigerato in vitroceramica. Temperatura regolabile da -5 a +15°C. Comando remoto.	<b>ES_</b> Placa de vidrio ceramica refrigerada. Temperatura regulable de -5 a +15°C. Comando a distancia.	<b>FR_</b> Plateau réfrigéré en vitrocéramique. Température réglable de -5 à +15°C. Commande à distance.	2 GN 1/1 cm 53x66  170W - 230V - 50/60Hz			
		COL55	<b>EN_</b> Refrigerated 18/10-AISI 304 stainless steel basin. Remote control.	<b>IT_</b> Vasca refrigerata in acciaio inossidabile 18/10-AISI 304. Comando remoto.	<b>ES_</b> Cubeta refrigerada de acero inoxidable 18/10-AISI 304. Comando a distancia.	<b>FR_</b> Bac réfrigérée en acier inoxydable 18/10-AISI 304. Commande à distance.	3 GN 1/1 cm 106x62 depth cm 3  350W - 220V - 50Hz			
		COL56	<b>EN_</b> Refrigerated 18/10-AISI 304 stainless steel basin. Adjustable temperature from -5 to +8°C. Remote control.	<b>IT_</b> Vasca refrigerata in acciaio inossidabile 18/10-AISI 304. Temperatura regolabile da -5 a +8°C. Comando remoto.	<b>ES_</b> Cubeta refrigerada de acero inoxidable 18/10-AISI 304. Temperatura regulable de -5 a +8°C. Comando a distancia.	<b>FR_</b> Bac réfrigérée en acier inoxydable 18/10-AISI 304. Température réglable de -5 à +8°C. Commande à distance.	6 GN 1/1 cm 205x63 depth cm 3  256W - 220V - 50Hz			

ICE BASINS	Appliances	Code	Description				Technical info	cm 160x80x(h)82	cm 210x80x(h)82	cm 250x80x(h)82
		ICE57	<b>EN_</b> 18/10-AISI 304 stainless steel ice basin.	<b>IT_</b> Vasca per ghiaccio in acciaio inossidabile 18/10-AISI 304.	<b>ES_</b> Cubeta para hielo en acero inoxidable 18/10-AISI 304.	<b>FR_</b> Bac à glace en acier inoxydable 18/10-AISI 304.	2 GN 1/1 cm 62x74 depth cm 10,9			
	ICE58	<b>EN_</b> 18/10-AISI 304 stainless steel ice basin.	<b>IT_</b> Vasca per ghiaccio in acciaio inossidabile 18/10-AISI 304.	<b>ES_</b> Cubeta para hielo en acero inoxidable 18/10-AISI 304.	<b>FR_</b> Bac à glace en acier inoxydable 18/10-AISI 304.	3 GN 1/1 cm 106x62 depth cm 10,9				



# COOK & self service



This collection represents the perfect union between a professional kitchen and the self-service. The large tabletop guarantees a direct contact that will allow not only the customer to be able to take part in the culinary preparation, but also the Chef to carry out his art with manageability and speed. These tables represent the perfect product of presentation and service.

*IT\_* Questa collezione rappresenta la perfetta unione tra una cucina professionale e il servizio self-service. Il grande piano d'appoggio garantisce un servizio diretto che permetterà non solo al cliente di poter prendere parte alla preparazione culinaria, ma anche allo Chef di poter svolgere la propria arte con maneggevolezza e velocità. Questi tavoli rappresentano il prodotto perfetto di presentazione e servizio.

*ES\_* Esta colección representa la unión perfecta entre una cocina profesional y el servicio de self-service. La gran superficie de la mesa asegura un contacto directo que permitirá que no solo el cliente pueda participar en la preparación culinaria, sino también que el Chef pueda llevar a cabo su arte con facilidad y rapidez. Estas mesas representan el producto perfecto de presentación y servicio.

*FR\_* Cette collection représente l'union parfaite entre une cuisine professionnelle et le service self-service. Le grand plateau de table assure un service direct qui permettra non seulement au client de participer à la préparation culinaire, mais également au Chef cuisinier de pouvoir exercer son art avec simplicité et rapidité. Ces tables représentent le produit parfait de présentation et de service.



**Basic models are available in three different sizes and can be used neutral or equipped with a wide range of appliances and optional.**

*IT\_* I modelli di base sono disponibili in tre differenti misure e possono essere utilizzati neutri oppure equipaggiati con una vasta gamma di applicazioni ed optional.  
*ES\_* Los modelos básicos están disponibles en tres tamaños diferentes y pueden utilizarse de manera neutral o equipados con una amplia gama de aplicaciones y opcionales.  
*FR\_* Les modèles de base sont disponibles en trois tailles différentes et peuvent être utilisés neutres ou équipés d'un large éventail d'applications et d'optionals.



Table sizes

**ART. COOK 160**  
cm 160x80x(h)82

**MODEL C:**  
No plates holding compartment.

**ART. COOK 210**  
cm 210x80x(h)82

**MODEL C:**  
No plates holding compartment.

**ART. COOK 250**  
cm 250x80x(h)82

**MODEL C:**  
No plates holding compartment.

**Basic models are available in two different sizes and can be used neutral or equipped with a wide range of appliances and optional.**

*IT\_* I modelli di base sono disponibili in due differenti misure e possono essere utilizzati neutri oppure equipaggiati con una vasta gamma di applicazioni ed optional.  
*ES\_* Los modelos básicos están disponibles en dos tamaños diferentes y pueden utilizarse de manera neutral o equipados con una amplia gama de aplicaciones y opcionales.  
*FR\_* Les modèles de base sont disponibles en deux tailles différentes et peuvent être utilisés neutres ou équipés d'un large éventail d'applications et d'optionals.



Table sizes

**ART. SELF SERVICE 210**  
cm 210x80x(h)82

**MODEL A:**  
Two plates holding compartments: cm 120x30x(h)17

**MODEL B:**  
One plates holding compartment: cm 120x30x(h)17

**ART. SELF SERVICE 250**  
cm 250x80x(h)82

**MODEL A:**  
Two plates holding compartments: cm 132x30x(h)17

**MODEL B:**  
One plates holding compartment: cm 132x30x(h)17



**These tables can be equipped with one or two plates holder.**

*IT\_* Questi tavoli possono essere equipaggiati di uno o due porta piatti.

*ES\_* Estas mesas pueden equiparse con uno o dos soportes de platos.

*FR\_* Ces tables peuvent être équipées d'un ou deux porte-assiettes.

**MODEL A - TWO PLATES HOLDERS**

**MODELLO A 210**



**MODELLO A 250**

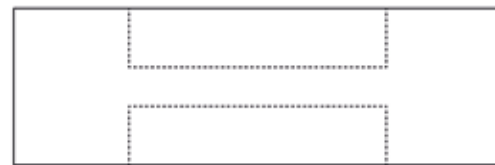

**EN\_ This table can be customized only in colours. Appliances can not be apply.**

*IT\_* Questo tavolo può essere personalizzato solo nei colori. Le applicazioni non possono essere inserite.

*ES\_* Esta mesa puede ser personalizada solamente en los colores. Las aplicaciones no pueden ser insertadas.

*FR\_* Ce table peut être personnalisé uniquement en couleurs. Les applications ne peuvent pas être appliquées.

**MODEL B - ONE PLATES HOLDER**

**MODELLO B 210**

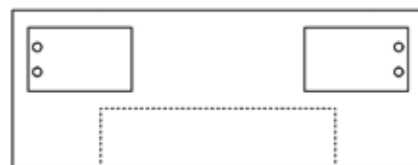

**MODELLO B 250**

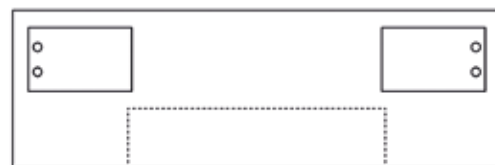

**EN\_ This table can be customized in colours and appliances.**

*IT\_* Questo tavolo può essere personalizzato in colori e applicazioni.

*ES\_* Esta mesa puede ser personalizada en colores y aplicaciones.

*FR\_* Ce table peut être personnalisé en couleurs et en applications.

**MODEL C - NO PLATES HOLDER**

**MODELLO C 210**

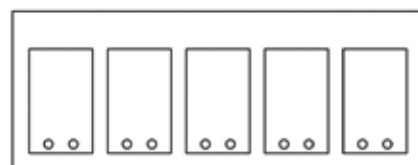

**MODELLO C 250**

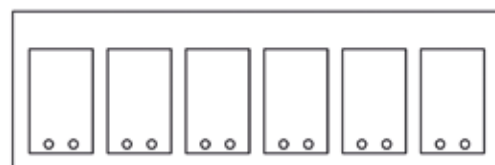

**EN\_ This table can be customized in colours and appliances.**

*IT\_* Questo tavolo può essere personalizzato in colori e applicazioni.

*ES\_* Esta mesa puede ser personalizada en colores y aplicaciones.

*FR\_* Ce table peut être personnalisé en couleurs et en applications.

**Cooking appliances**



X5  
cm 60  
h cm 24

**EN\_ Protection in tempered glass and 18/10 stainless steel.**

*IT\_* Protezione in vetro temperato e acciaio inossidabile 18/10.

*ES\_* Protección en vidrio templado y acero inoxidable 18/10.

*FR\_* Protection en verre trempé et acier inoxydable 18/10.



DOM25  
cm 30,2x52  
220 - 240V 1N ~  
/ 3,7kW

**EN\_ Induction hob - 3 cooking zones. Glass-ceramic with blunted front side and lateral profiles in stainless steel.**

*IT\_* Piano cottura ad induzione - 3 postazioni di cottura. Vetroceramica con frontale smussato e profili in acciaio inossidabile.

*ES\_* Placa de inducción - 3 zonas de cocción. Vitrocerámica con frente romo y perfiles laterales an acero inoxidable.

*FR\_* Plaque à induction - 3 zones de cuisson. Vitrocéramique avec façade biseautées et profils latéraux en acier inoxydable.



DOM15  
cm 38x52  
230V ~ 1P+N  
50/60Hz

**EN\_ Induction glass-ceramic hob - 1 cooking zone.**

*IT\_* Piano cottura ad induzione in vetroceramica - 1 postazione di cottura.

*ES\_* Placa de inducción en vitrocerámica - 1 zona de cocción.

*FR\_* Plaque à induction en vitrocéramique - 1 zone de cuisson.



DOM12  
cm 40x52  
220-230V  
50/60Hz

**EN\_ Induction glass-ceramic wok hob.**

*IT\_* Piano cottura ad induzione wok in vetro ceramica.

*ES\_* Encimera wok de inducción en vitrocerámica.

*FR\_* Table de cuisson wok à induction en vitrocéramique.



DOM26  
cm 30,2x52  
220-240V / 50/60Hz

**EN\_ Glass-ceramic hob - 2 cooking zones.**

*IT\_* Piano cottura in vetroceramica - 2 postazioni di cottura.

*ES\_* Placa en vitrocerámica - 2 zonas de cocción.

*FR\_* Plaque en vitrocéramique - 2 zones de cuisson.



DOM33  
cm 39x52  
220 - 240V / 1,9kW

**EN\_ TeppanYaki plate.**

*IT\_* Piastra TeppanYaki.

*ES\_* Placa TeppanYaki.

*FR\_* Plaque TeppanYaki.



DOM5  
cm 39,2x52  
220 - 240V / 3,4kW

**EN\_ Lava stone grill plate.**

*IT\_* Piastra grill a pietra lavica.

*ES\_* Placa grill de piedra de lava.

*FR\_* Plaque grill en pierre de lave.

### Some examples

## Table equipped with induction glass-ceramic hob.

cm 30x52 - 220 - 240V 1N /3,7kW.



IT\_ Tavolo equipaggiato con piano cottura ad induzione in vitroceramica.  
 ES\_ Mesa equipada de placa de inducción en vitrocerámica.  
 FR\_ Table équipé de plaque à induction en vitrocéramique.



ART. COOK 210/W5/DOM25

colours available	matt finish	W1	B1	C2
	climb finish	W5	B2	C1
	ultra matt finish	W2	B6	C7

### Some examples

## Table equipped with two induction glass-ceramic hobs and protection in tempered glass and 18/10-AISI 304 stainless steel.

cm 30x52 - 220 - 240V 1N /3,7kW.



IT\_ Tavolo equipaggiato con due piani cottura ad induzione in vitroceramica e protezione in vetro temperato e acciaio inossidabile 18/10-AISI 304.  
 ES\_ Mesa equipada de dos placas de inducción en vitrocerámica y protección en vidrio templado y acero inoxidable 18/10-AISI 304.  
 FR\_ Table équipé avec deux plaques à induction en vitrocéramique et protection en verre trempé et acier inoxydable 18/10-AISI 304.



ART. SELF SERVICE 250/MODELB/B2/DOM25/DOM25/X5/X5

Appliances: see page 47.

colours available	matt finish	W1	B1	C2
	climb finish	W5	B2	C1
	ultra matt finish	W2	B6	C7



# neo



This collection of restaurant tables is the protagonist of our “gastronomy”. The innovative materials used in the production make them strong, durable and easy to clean, without neglecting design and aesthetics. The valuable finishes also make them elegant and modern.

*IT\_* Questa collezione di tavoli da ristorante è la protagonista della nostra “gastronomia”. I materiali innovativi utilizzati nella produzione li rendono forti, duraturi e di facile mantenimento, senza trascurare design ed estetica. Le finiture di pregio li rendono inoltre eleganti e moderni.

*ES\_* Esta colección de mesas de restaurante es la protagonista de nuestra “gastronomía”. Los materiales innovadores utilizados en sus producción, los ponen fuertes, duraderos y de facil mantenimiento, sin descuidar el design y la estética. Los preciosos acabados los rinden, además, elegantes y modernos.

*FR\_* Cette collection de tables de restaurant est le protagoniste de notre “gastronomie”. Les matériaux innovants utilisés dans la production les rendent solides, durables et faciles à nettoyer, sans pour autant négliger le design et l’esthétique. Les finitions raffinées les rendent également élégantes et modernes.



NEO / HIGH PRESSURE LAMINATE - MIRROR FINISH STAINLESS STEEL



**Tables are available in three different sizes.**

*IT\_* I tavoli sono disponibili in tre differenti misure.

*ES\_* Mesas estan disponible en tres tamaños diferentes.

*FR\_* Les tables sont disponible en trois tailles différentes.



ART. NEO 90/W2  
cm 90x80x(h)80



ART. NEO 160/W2  
cm 160x80x(h)80



ART. NEO 210/W2  
cm 210x80x(h)80

**Simple and elegant restaurant tables,  
embellished with mirror finish  
18/10-AISI 304 stainless steel details.**

*IT\_* Tavoli da ristorante semplici ed eleganti, impreziositi da dettagli in acciaio inossidabile 18/10-AISI 304 lucidato a specchio.

*ES\_* Mesas de restaurante sencillas y elegantes, adornadas con detalles des acero inoxidable 18/10-AISI 304 acabado espejo.









*FR\_* Tables de restaurant simples et élégantes, agrémentées de détails en acier inoxydable 18/10-AISI 304 poli miroir.

Table sizes

ART. NEO 90  
cm 90x80x(h)80

ART. NEO 160  
cm 160x80x(h)80

ART. NEO 210  
cm 210x80x(h)80

colours available	matt finish		
	 W1	 B1	 C2
	 W5	 B2	 C1
ultra matt finish			
 W2	 B6	 C7	

# star



**STAR is a simple and essential collection of tables for hotel lobbies, which with its elegance is suitable for all receptions and waiting areas, making them cozy and comfortable.**

*IT\_* STAR è una collezione di tavoli per le hall d'albergo semplice ed essenziale, che con la sua eleganza si adatta a tutti gli ambienti di accoglienza e attesa, rendendoli ospitali e confortevoli.

*ES\_* STAR es una colección de mesas simple y esencial para los vestíbulos de hoteles, que con su elegancia se conforma a todos los entornos de recepción y espera, volviéndolos acogedores y confortables.

*FR\_* STAR est une collection simples et essentiels de tables pour les halls d'hôtel qui, avec son élégance, convient à toutes les zones de réception et d'attente, les rendant ainsi accueillantes et confortables.



**Basic model available in three different sizes.**

*IT\_* Modello base disponibile in tre differenti misure.

*ES\_* Modelo básico disponible en tres tamaños diferentes.

*FR\_* Modèle de base disponible en trois tailles différentes.



ART. STAR 90/W2  
cm 90x80x(h)26



ART. STAR 160/W2  
cm 160x80x(h)26



ART. STAR 210/W2  
cm 210x80x(h)26

**Linear and essential lobby tables, embellished with the structure in 18/10-AISI 304 stainless steel, which adapts to any environment making it cozy and comfortable.**

*IT\_* Tavoli da hall lineari ed essenziali, impreziositi dalla struttura in acciaio inossidabile 18/10-AISI 304, che si adattano ad ogni ambiente rendendolo ospitale e confortevole.

*ES\_* Mesas para los vestibulos de hoteles lineales y esenciales, embellecidas por la estructura en acero inoxidable 18/10-AISI 304, que se adapta a cualquier entorno haciéndolo acogedor y confortable.

*FR\_* Tables pour les halls d'hôtel linéaires et essentielles, embellies par la structure en acier inoxydable 18/10-AISI 304 poli miroir, qui s'adapte à n'importe quel environnement, le rendant hospitalier et confortable.

Table sizes

ART. STAR 90  
cm 90x80x(h)26

ART. STAR 160  
cm 160x80x(h)26

ART. STAR 210  
cm 210x80x(h)26

colours available	matt finish	W1	B1	C2
	climb finish	W5	B2	C1
	ultra matt finish	W2	B6	C7

# MOON



**MOON is a simple and essential collection of tables for hotel lobbies, which with its elegance is suitable for all receptions and waiting areas, making them cozy and comfortable.**

*IT\_* MOON è una collezione di tavoli per le hall d'albergo semplice ed essenziale, che con la sua eleganza si adatta a tutti gli ambienti di accoglienza e attesa, rendendoli ospitali e confortevoli.

*ES\_* MOON es una colección de mesas simple y esencial para los vestíbulos de hoteles, que con su elegancia se conforma a todos los entornos de recepción y espera, volviéndolos acogedores y confortables.

*FR\_* MOON est une collection simples et essentiels de tables pour les halls d'hôtel qui, avec son élégance, convient à toutes les zones de réception et d'attente, les rendant ainsi accueillantes et confortables.



**Basic model available in three different sizes.**

*IT\_* Modello base disponibile in tre differenti misure.

*ES\_* Modelo básico disponible en tres tamaños diferentes.

*FR\_* Modèle de base disponible en trois tailles différentes.



ART. MOON 90/B2  
cm 90x80x(h)23



ART. MOON 160/B2  
cm 160x80x(h)23



ART. MOON 210/B2  
cm 210x80x(h)23

**Linear and essential lobby tables  
which adapts to any environment  
making it cozy and comfortable.**

*IT\_* Tavoli da hall lineari ed essenziali che si adatto ad ogni ambiente rendendolo ospitale e confortevole.

*ES\_* Mesas para los vestibulos de hoteles lineales y esenciales que se adaptan a cualquier entorno haciéndolo acogedor y confortable.

*FR\_* Tables pour les halls d'hôtel linéaires et essentielles qui s'adapte à n'importe quel environnement, le rendant hospitalier et confortable.

Table sizes

ART. MOON 90  
cm 90x80x(h)23

ART. MOON 160  
cm 160x80x(h)23

ART. MOON 210  
cm 210x80x(h)23

colours available	matt finish	W1	B1	C2
	climb finish	W5	B2	C1
	ultra matt finish	W2	B6	C7



# modular tables

A family of compatible and modular tables, available fixed or with adjustable height. They can be placed side by side to offer endless combinations of presentation and at the same time allow a space of minimum encumbrance when not in use thanks to the possibility of being stacked. Perfect both as a buffet table and as a high cocktail table or a table where you can eat standing up. Thanks to their flexibility and multi-functionality, these design tables represent a valid solution for hotels, restaurants and bars.

*IT\_* Una famiglia di tavoli compatibili e modulari, disponibili fissi oppure ad altezza regolabile. Possono essere accostati per offrire infinite combinazioni di presentazione e allo stesso tempo consentire uno spazio di ingombro minimo quando non in uso grazie alla possibilità di essere impilati. Perfetti sia come tavoli da buffet, sia come tavoli alti da cocktail o tavoli mangia in piedi. Grazie alla loro flessibilità e multifunzionalità, questi tavoli di design rappresentano una valida soluzione per gli hotel, i ristoranti e i bar.

*ES\_* Una familia de mesas compatibles y modulares, disponibles fijas o con altura regulable. Se pueden colocar lado a lado para ofrecer infinitas combinaciones de presentación y, al mismo tiempo, permiten un espacio de volumen mínimo cuando no están en uso gracias a la posibilidad de apilarse. Perfecto tanto como una mesa de buffet y como una mesa alta de cóctel o una mesa donde se puede comer de pie. Gracias a su flexibilidad y multifuncionalidad, estas mesas de diseño representan una solución válida para hoteles, restaurantes y bares.

*FR\_* Une famille de tables compatibles et modulaires, disponibles en version fixe ou à hauteur réglable. Ils peuvent être placés côte à côte pour offrir une infinité de combinaisons de présentation tout en ménageant un espace d'encombrement minimal lorsqu'ils ne sont pas utilisés, grâce à la possibilité d'empilement. Parfait à la fois comme table de buffet et comme table de cocktail haute ou comme table où vous pouvez manger debout. Grâce à leur flexibilité et leur multifonctionnalité, ces tables de design représentent une solution valable pour les hôtels, les restaurants et les bars.



**Available in white and black climb finish.**

*IT\_* Disponibili in bianco e nero con finitura climb.  
*ES\_* Disponible en blanco y negro con acabado climb.  
*FR\_* Disponible en noir et blanc avec finition climb.

**finishes**

**CLIMB**

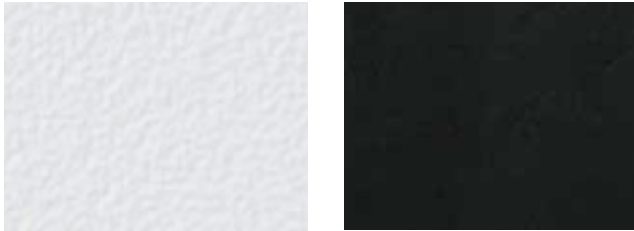

**W5**  
white climb

**B2**  
black ardesia

**Customization of all tables on request.  
See page 68 and contact our sales office.**



**1**  
Made of a 12 mm high pressure laminate panel.

*IT\_* Realizzati con un pannello di laminato ad alta pressione da 12 mm.

*ES\_* Fabricado con un panel laminado de alta presión de 12 mm.

*FR\_* Fabriqués en stratifié haute pression de 12 mm.

**2**  
Structure made of 18/10-AISI 304 brushed stainless steel.

*IT\_* Struttura realizzata in acciaio inossidabile 18/10-AISI 304 satinato.

*ES\_* Estructura realizada en acero inoxidable 18/10-AISI 304 satinado.

*FR\_* Structure en acier inoxydable 18/10-AISI 304 satiné.

**3**  
Equipped with 4 pivoting, non-marking wheels with brakes, to facilitate service maneuvers and storage.

*IT\_* Muniti di 4 ruote pivotanti, antitraccia e dotate di freno, per facilitare la manovre di servizio e stoccaggio.

*ES\_* Equipado con 4 ruedas pivotantes, que no dejan marcas, con frenos para facilitar las operaciones de servicio y almacenamiento.

*FR\_* Equipé de 4 roues pivotantes, non marquantes avec freins, pour faciliter les manœuvres d'entretien et stockage.



**High pressure laminate**

*IT\_* Laminato ad alta pressione  
*ES\_* Laminado de alta presión  
*FR\_* Stratifié haute pression

**EN\_ Revolution and innovation in an excellent material thanks to its functional and aesthetic potentialities. Anti-scratch, waterproof, resistant to oils, steam and water. Unalterable up to 60°, anti bacterial and long lasting.**

*IT\_* Rivoluzione ed innovazione in un materiale eccellente per le sue potenzialità funzionali ed estetiche. Anti-graffio, impermeabile, resiste ad oli, vapore ed acqua. Inalterabile fino a 60°, anti batterico e duraturo.

*ES\_* Revolución e innovación en un material excelente por sus potencialidades funcionales y estéticas. Anti-rasguños, impermeable, resistente a aceites, vapor y agua. Inalterable hasta 60°, antibacteriano y de larga duración.

*FR\_* Révolution et innovation dans un excellent matériau pour ses potentialités fonctionnelles et esthétiques. Anti-rayures, imperméable, résistant aux huiles, à la vapeur et à l'eau. Inaltérable jusqu'à 60°, anti bactérien et durable.

**Stainless steel 18/10-AISI 304 brushed**

*IT\_* Acciaio inossidabile 18/10-AISI 304 - Satinato  
*ES\_* Acero inoxidable 18/10-AISI 304 - Satinado  
*FR\_* Acier inoxydable 18/10-AISI 304 - Satiné

**EN\_ Rigorous in its shapes for a linear and functional aesthetic. 100% recyclable, no maintenance, corrosion resistance and mechanical features are some of the connotations that make it an essential material.**

*IT\_* Rigoroso nelle sue forme per un'estetica lineare e funzionale. 100% riciclabile, assenza di manutenzione, resistenza alla corrosione e caratteristiche meccaniche di rilievo sono alcune delle connotazioni che lo rendono un prodotto imprescindibile.

*ES\_* Riguroso en sus formas para una estética lineal y funcional. 100% reciclable, sin mantenimiento, resistencia a la corrosión y características mecánicas significativas son algunas de las connotaciones que lo convierten en un producto esencial.

*FR\_* Rigoureux dans ses formes pour une esthétique linéaire et fonctionnelle. 100% recyclable, pas d'entretien, résistance à la corrosion et caractéristiques mécaniques sont des connotations qui en font un produit essentiel.





**Set of two stackable tables, available in two colours - Black Ardesia and White Climb.**

*IT\_* Set di due tavoli impilabili, disponibili in due varianti colore - Black Ardesia e White Climb.

*ES\_* Juego de dos mesas apilables, disponibles en dos colores - Black Ardesia y White Climb.

*FR\_* Ensemble de deux tables empilables, disponibles en deux couleurs - Black Ardesia et White Climb.

**Basic model available in two different sizes.**

*IT\_* Modello base disponibile in due differenti misure.

*ES\_* Modelo básico disponible en dos tamaños diferentes.

*FR\_* Modèle de base disponible en deux tailles différentes.



ART. SMART 160/W5  
cm 160x80x(h)78



ART. SMART 206/W5  
cm 206x80x(h)88

Optional: Protection - see page 68.

Optional protection



ART. X1

**EN\_ Neutral polycarbonate protection.**  
*IT\_ Protezione neutra in policarbonato.*  
*ES\_ Protección neutra de policarbonato.*  
*FR\_ Protection neutre en polycarbonate.*



ART. X2

**EN\_ Neutral tempered glass protection and plates holder.**  
*IT\_ Protezione e appoggio per piatti neutro in vetro temperato.*  
*ES\_ Protección y soporte de platos neutro de vidrio templado.*  
*FR\_ Protection et porte-assiettes neutre en verre trempé.*



ART. SMART 206B/W5/X1  
 cm 206x80x(h)88+55

**Table with shelf.**  
 cm 206x80x(h)88.

*IT\_ Tavolo con ripiano.*  
*ES\_ Mesa con estante.*  
*FR\_ Table avec étagère.*



ART. SMART 206B/W5  
 cm 206x80x(h)88

colours available

climb finish

W5

B2

Optional

**Neutral polycarbonate protection.**

*IT\_ Protezione neutra in policarbonato.*

*ES\_ Protección neutra de policarbonato.*

*FR\_ Protection neutre en polycarbonate.*





**Set of three stackable tables with telescopic legs, available in two colours - Black Ardesia and White Climb.**

*IT\_* Set di tre tavoli impilabili con gambe telescopiche, disponibili in due varianti colore - Black Ardesia e White Climb.

*ES\_* Juego de tres mesas apilables con patas telescópicas, disponibles en dos colores - Black Ardesia y White Climb.

*FR\_* Ensemble de trois tables empilables avec pieds télescopiques, disponibles en deux couleurs - Black Ardesia et White Climb.



ART. DOMINO 206/W5  
cm 206x80x(h)92

ART. DOMINO 160/W5  
cm 160x80x(h)80/92

ART. DOMINO 100/W5  
cm 100x80x(h)70/80/92



1

**1** Telescopic legs to get up to three heights.

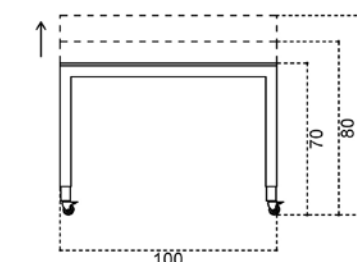
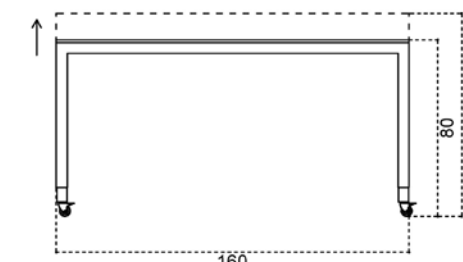

*IT\_* Gambe telescopiche per ottenere fino a tre altezze.

*ES\_* Patas telescópicas para conseguir hasta tres alturas.

*FR\_* Pieds télescopiques pour atteindre trois hauteurs.

**Basic model available in three different sizes.**

*IT\_* Modello base disponibile in tre differenti misure.

*ES\_* Modelo básico disponible en tres tamaños diferentes.

*FR\_* Modèle de base disponible en trois tailles différentes.

colours available

climb finish

W5

B2



ART. DOMINO 100/W5  
cm 100x80x(h)70/80/92



ART. DOMINO 160/W5  
cm 160x80x(h)80/92



ART. DOMINO 206/W5  
cm 206x80x(h)92

ART. 7124

**Service trolley complete with two plastic baskets.**

*IT\_* Carrello di servizio con due cestini in plastica.

*ES\_* Carrito de servicio con dos cestas en plastico.

*FR\_* Chariot de service avec deux panier en plastique.



ART. 7123

**Service trolley.**

*IT\_* Carrello di servizio.

*ES\_* Carrito de servicio.

*FR\_* Chariot de service.



top	size	cm 100x50x(h)87+8
	max cap.	kg 60
shelves	size	cm 100x50
	max cap.	kg 60



# counters

Buffet counters, the most effective solution for storing and displaying a wide variety of foods in hotels, restaurants and catering. Designed on wheels, they can be easily dislocated and used for breakfast, lunch and dinner buffets. Available in warm, refrigerated and neutral models, they are ideal not only to keep alterable foods at temperature, but also non-perishable foodstuffs.

*IT\_* Banchi buffet ad isola, la soluzione più efficace per conservare ed esporre una grande varietà di alimenti in strutture alberghiere, ristoranti e catering. Ideati su ruote possono essere facilmente dislocati ed utilizzati durante i servizi buffet di colazione, pranzo e cena. Disponibili in modelli caldi, refrigerati e neutri, sono ideali non solo per mantenere a temperatura i cibi alterabili, ma anche generi alimentari non deperibili.

*ES\_* Mostradores de buffet, la solución más efectiva para almacenar y mostrar una amplia variedad de alimentos en hoteles, restaurantes y catering. Diseñados sobre ruedas, pueden disolverse fácilmente y usarse para los bufets de desayuno, almuerzo y cena. Disponibles en modelos cálidos, refrigerados y neutros, son ideales no solo para mantener los alimentos alterables a temperatura, sino también los alimentos no perecederos.

*FR\_* Comptoirs de buffet la solution la plus efficace pour stocker et afficher une grande variété de plats dans les hôtels, les restaurants et les catering. Conçus sur roues, ils peuvent être facilement déplacés et utilisés pour les buffets de petit-déjeuner, déjeuner et dîner. Disponibles en modèles chauds, réfrigérés et neutres, elles sont idéales non seulement pour conserver les aliments interchangeables à la température, mais également pour les aliments non périssables.





## Tetris



**1**  
Made of poplar wood covered with 9/10 high pressure laminate.

*IT\_* Realizzati in legno di pioppo rivestito da laminato ad alta pressione da 9/10.

**2**  
Available with worktop in 18/10-AISI 304 stainless steel.

*IT\_* Disponibile con piano di lavoro in acciaio inossidabile 18/10-AISI 304.

**3**  
Equipped with 6 pivoting, non-marking wheels with brakes, to facilitate service maneuvers and storage.

*IT\_* Muniti di 6 ruote pivotanti, antitraccia e dotate di freno, per facilitare le manovre di servizio e stoccaggio.

## Idea



*ES\_* Hecho en madera de álamo revestido de laminado de alta presión 9/10.

*ES\_* Disponible con llano de trabajo en acero inoxidable 18/10-AISI 304.

*ES\_* Equipado con 6 ruedas rotatorias, antihuellas y con frenos, para facilitar las maniobras de servicio y almacenamiento.

*FR\_* Fabriqués en bois de peuplier recouvert de stratifié haute pression de 9/10.

*FR\_* Disponible avec plan de travail en acier inoxydable 18/10-AISI 304.

*FR\_* Equipé de 6 roues pivotantes, non marquantes avec freins, pour faciliter les manœuvres d'entretien et stockage.

finishes

### MATT

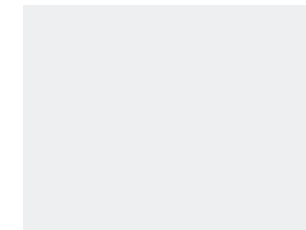

**W1**  
white ice

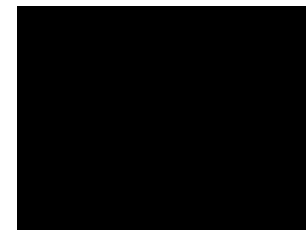

**B1**  
black



**C2**  
walkprint

### CLIMB

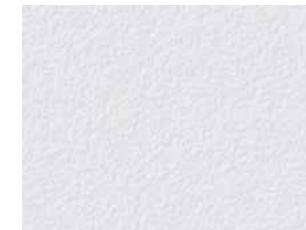

**W5**  
white climb

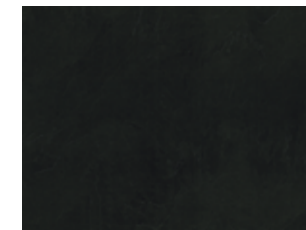

**B2**  
black ardesia



**C1**  
greige

### MOD ULTRA MATT

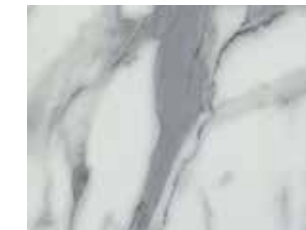

**W2**  
calacatta



**B6**  
impero



**C7**  
navajo

### WOOD



**R1**  
ash



**Q1**  
cherry rose

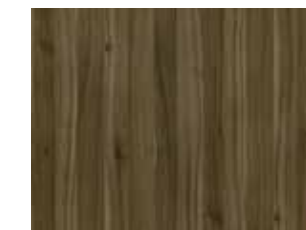

**A1**  
nancy elm





**E1**  
wengé congo



**U1**  
pearl elm

Customization of all trolleys on request. See pages 78-81 and contact our sales office.

Appliances available:

Appliances	Code	Description				Techincal info	TETRIS 34	TETRIS 35	IDEA 51	IDEA 52
		EN_	IT_	ES_	FR_					
	COL54	<b>EN_</b> Refrigerated glass-ceramic top. Adjustable temperature from -5 to +15°C. Remote control.	<b>IT_</b> Piano refrigerato in vetroceramica. Temperatura regolabile da -5 a +15°C. Comando remoto.	<b>ES_</b> Placa de vidrio ceramica refrigerada. Temperatura regulable de -5 a +15°C. Comando a distancia.	<b>FR_</b> Plateau réfrigéré en vitrocéramique. Température réglable de -5 à +15°C.	2 GN 1/1 cm 53x66  170W - 230V - 50/60Hz	●		●	
	COL55	<b>EN_</b> Refrigerated 18/10-AISI 304 stainless steel basin. Remote control.	<b>IT_</b> Vasca refrigerata in acciaio inossidabile 18/10-AISI 304. Comando remoto.	<b>ES_</b> Cubeta refrigerada de acero inoxidable 18/10-AISI 304. Comando a distancia.	<b>FR_</b> Bac réfrigérée en acier inoxydable 18/10-AISI 304. Commande à distance.	3 GN 1/1 cm 106x62 depth cm 3  350W - 220V - 50Hz				
	COL56	<b>EN_</b> Refrigerated 18/10-AISI 304 stainless steel basin. Adjustable temperature from -5 to +8°C. Remote control.	<b>IT_</b> Vasca refrigerata in acciaio inossidabile 18/10-AISI 304. Temperatura regolabile da -5 a +8°C. Comando remoto.	<b>ES_</b> Cubeta refrigerada de acero inoxidable 18/10-AISI 304. Temperatura regulable de -5 a +8°C. Comando a distancia.	<b>FR_</b> Bac réfrigérée en acier inoxydable 18/10-AISI 304. Température réglable de -5 à +8°C.	6 GN 1/1 cm 205x63 depth cm 3  256W - 220V - 50Hz	●		●	

COLD MAINTENANCE APPLIANCES





Appliances	Code	Description				Techincal info	TETRIS 34	TETRIS 35	IDEA 51	IDEA 52
		EN_	IT_	ES_	FR_					
	IND50	<b>EN_</b> Induction glass-ceramic top heat-retaining unit. Remote control.	<b>IT_</b> Unità di mantenimento del calore ad induzione in vitroceramica. Comando remoto.	<b>ES_</b> Unidad de mantenimiento de calor por inducción de vitrocerámica. Comando a distancia.	<b>FR_</b> Unité de chauffage par induction en vitrocéramique. Commande à distance.	2x cm 32x32 2x cm 52x32  230V - 3,2kW	●		●	
	IND51	<b>EN_</b> Induction glass-ceramic top heat-retaining unit. Remote control.	<b>IT_</b> Unità di mantenimento del calore ad induzione in vitroceramica. Comando remoto.	<b>ES_</b> Unidad de mantenimiento de calor por inducción de vitrocerámica. Comando a distancia.	<b>FR_</b> Unité de chauffage par induction en vitrocéramique. Commande à distance.	cm 80x40  230V - 1,5kW	●		●	
	HOT52	<b>EN_</b> 18/10-AISI 304 stainless steel heating plate. Adjustable temperature from +30 to +90°C. Remote control.	<b>IT_</b> Piano caldo in acciaio inossidabile 18/10-AISI 304. Temperatura regolabile da +30 a +90°C. Comando remoto.	<b>ES_</b> Placa calentadora en acero inoxidable 18/10-AISI 304. Temperatura regulable de +30 a +90°C. Comando a distancia.	<b>FR_</b> Plateau chauffante en acier inoxydable 18/10-AISI 304. Température réglable de +30 à +90°C. Commande à distance.	2 GN 1/1 cm 69x62  600W - 230V - 50/60Hz	●		●	
	HOT53	<b>EN_</b> 18/10-AISI 304 stainless steel heating plate. Adjustable temperature from +30 to +90°C. Remote control.	<b>IT_</b> Piano caldo in acciaio inossidabile 18/10-AISI 304. Temperatura regolabile da +30 a +90°C. Comando remoto.	<b>ES_</b> Placa calentadora en acero inoxidable 18/10-AISI 304. Temperatura regulable de +30 a +90°C. Comando a distancia.	<b>FR_</b> Plateau chauffante en acier inoxydable 18/10-AISI 304. Température réglable de +30 à +90°C. Commande à distance.	6 GN 1/1 cm 194x52  200W - 230V - 50/60Hz	●		●	
	HOT55	<b>EN_</b> Three stainless steel chafing dish. GN 1/1, depth mm 65. Glass lid with stainless steel frame and soft closure. Complete with electric plate with regulator.	<b>IT_</b> Tre chafing dish in acciaio inossidabile. GN 1/1, profondità mm 65. Coperchio in vetro con cornice in acciaio inossidabile e chiusura ammortizzata. Completa di piastra elettrica con regolatore.	<b>ES_</b> Tres chafing dish en acero inoxidable. GN 1/1, profundidad mm 65. Tapa de vidrio con marco de acero inoxidable y cierre armonizado. Completo con placa eléctrica con regulador.	<b>FR_</b> Trois chafing dish en acier inoxydable. GN 1/1, profondeur mm 65. Couvercle en verre avec cadre en acier inoxydable et fermeture harmonisée. Complet avec plaque électrique avec régulateur.	cm 58x45x(h)25  400W - 230V				●

HOT MAINTENANCE APPLIANCES







COUNTERS / HIGH PRESSURE LAMINATE - STAINLESS STEEL



Optionals available:

OPTIONALS	Optionals	Code	Description				Technical info	TETRIS 34	TETRIS 35	IDEA 51	IDEA 52
		R200	<i>EN_</i> Perimeter barrier.	<i>IT_</i> Barriera perimetrale.	<i>ES_</i> Barrera perimetral.	<i>FR_</i> Barrière de périmètre.	cm 200	●		●	
	S	<i>EN_</i> Reclining plates stand.	<i>IT_</i> Scorripiatti reclinabile.	<i>ES_</i> Pasaplatos reclinable.	<i>FR_</i> Porte-assiettes rabattable.	cm 205x25	●	●	●	●	
	ANC1	<i>EN_</i> Anchor hook.	<i>IT_</i> Gancio di ancoraggio.	<i>ES_</i> Gancho anclado.	<i>FR_</i> Crochet d'ancorage.	Ø cm 9 h cm 4,5	●	●	●	●	
	ANG1	<i>EN_</i> Edge protection.	<i>IT_</i> Paraspigoli.	<i>ES_</i> Protección para bordes.	<i>FR_</i> Protection de bord.	Aluminum	●	●	●	●	
	Y8	<i>EN_</i> Protective work surface panels that turn the buffet counter into a useful support surface.	<i>IT_</i> Assi per protezione piano di lavoro che trasformano il banco buffet in un utile piano d'appoggio.	<i>ES_</i> Tablas para la protección del platos de trabajo que vuelven el banco buffet en un llano de apoyo.	<i>FR_</i> Panneaux de protection des surfaces de travail qui transforment le comptoir buffet en une surface de support utile.	Two panels cm 100x63//each	●	●	●	●	

PROTECTIONS

Optionals	Code	Description				Technical info	TETRIS 34	TETRIS 35	IDEA 51	IDEA 52
	X1	<i>EN_</i> Neutral polycarbonate protection.	<i>IT_</i> Protezione neutra in policarbonato.	<i>ES_</i> Protección neutra de policarbonato.	<i>FR_</i> Protection neutre en polycarbonate.		●	●	●	●
	Y1	<i>EN_</i> Polycarbonate protection with LED lighting.	<i>IT_</i> Protezione in policarbonato con illuminazione LED.	<i>ES_</i> Protección de policarbonato con iluminación LED.	<i>FR_</i> Protection en polycarbonate avec éclairage LED.	cm 205 h cm 55	●	●	●	●
	Z1	<i>EN_</i> Polycarbonate protection with heating lamp. Only to be combined with appliance Art. HOT53. See page 79.	<i>IT_</i> Protezione in policarbonato con lampada riscaldante. Abbinabile solo all'applicazione Art. HOT 53. Vedi pagina 79.	<i>ES_</i> Protección de policarbonato con lámpara de calentamiento. Para ser combinado solo con l'applicacion Art. HOT53. Ver página 79.	<i>FR_</i> Protection en polycarbonate avec lampe chauffante. Combinable seulement avec l'application Art. HOT53. Voir page 79.		●	●	●	●
	X2	<i>EN_</i> Protection and support for plates, neutral, in tempered glass.	<i>IT_</i> Protezione e appoggio per piatti, neutro, in vetro temperato.	<i>ES_</i> Protección y soporte para platos, neutros, de vidrio templado.	<i>FR_</i> Protection et support pour vaisselles, neutre, en verre trempé.		●	●	●	●
	Y2	<i>EN_</i> Protection and support for plates, with LED light, in tempered glass.	<i>IT_</i> Protezione e appoggio per piatti, con luce LED, in vetro temperato.	<i>ES_</i> Protección y soporte para placas, con luz LED, de vidrio templado.	<i>FR_</i> Protection et support pour vaisselles, avec éclairage LED, en verre trempé.	cm 205 h cm 50	●	●	●	●
	Y6	<i>EN_</i> Polycarbonate side protection for both sides. Only to be combined with Art. X1-Y1-Z1.	<i>IT_</i> Protezione laterale in policarbonato per ambo i lati. Compatibile solo con Art. X1-Y1-Z1.	<i>ES_</i> Protección lateral de policarbonato para ambos lados. Para ser combinado solo con los Art. X1-Y1-Z1.	<i>FR_</i> Protection latérale en polycarbonate des deux côtés. Combinable seulement avec les Art. X1-Y1-Z1.	cm 55,5 h cm 50	●	●	●	●



ART. TETRIS 34

### Neutral counter.

IT\_ Banco buffet neutro.  
 ES\_ Isla buffet neutra.  
 FR\_ Comptoir buffet neutre.

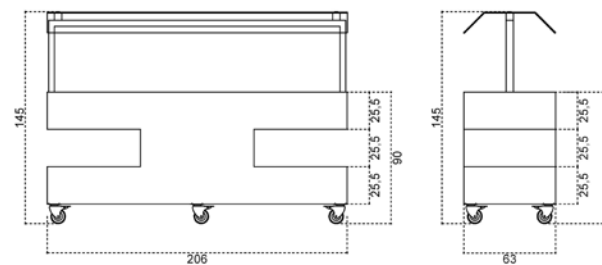
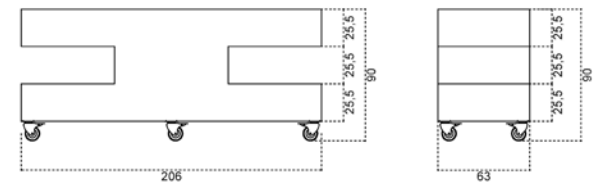

colours available	matt finish	W1	B1	C2
	climb finish	W5	B2	C1
	ultra matt finish	W2	B6	C7
	wood finish	R1	Q1	A1
		E1	U1	

Inner compartment



ART. TETRIS 36



ART. TETRIS 35

### Neutral counter with 18/10-AISI 304 stainless steel top surface.

IT\_ Banco buffet neutro con piano in acciaio inossidabile 18/10-AISI 304.  
 ES\_ Isla buffet neutra con llano de acero inoxidable 18/10-AISI 304.  
 FR\_ Comptoir buffet neutre avec plan de travail en acier inoxydable 18/10-AISI 304.

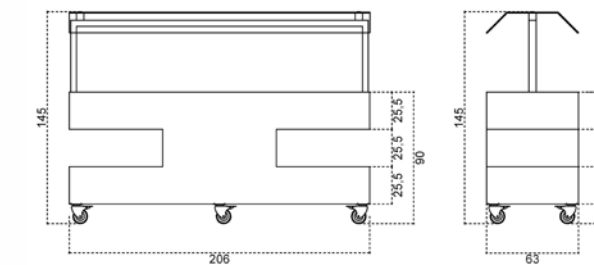
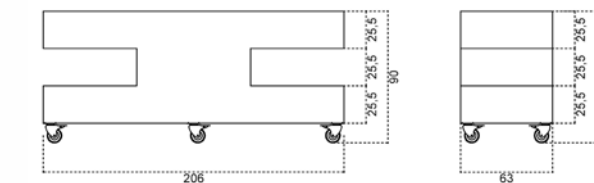

colours available	matt finish	W1	B1	C2
	climb finish	W5	B2	C1
	ultra matt finish	W2	B6	C7
	wood finish	R1	Q1	A1
		E1	U1	

## Some examples

**For each collection we will offer some examples of customization that can be applied to counters.**

*IT\_* Per ogni collezione proporremo alcuni esempi di personalizzazione che possono essere applicati ai banchi buffet.

*ES\_* Para cada colección ofreceremos algunos ejemplos de personalización que se pueden aplicar a las islas buffet.

*FR\_* Pour chaque collection, nous vous proposons quelques exemples de personnalisation qui pouvant être appliqués aux comptoirs.

***EN\_* Deagostini Inox offers its customers a personalized design service.**

**Contact our sales office and request a customized proposal regarding products, finishes, colours and technical equipment.**

**The technical office is at your disposal to combine our range of proposals based on your needs!**

*IT\_* La Deagostini Inox offre ai propri clienti un servizio di progettazione personalizzato. Contatta il nostro ufficio vendite e richiedi una proposta su misura in merito a prodotti, finiture, colori e attrezzature tecniche.

L'ufficio tecnico è a tua disposizione per combinare la nostra gamma di proposte in base alle tue esigenze!

*ES\_* Deagostini Inox ofrece a sus clientes un servicio de design personalizado.

Póngase en contacto con nuestra oficina de ventas y solicite una propuesta personalizada en cuanto a productos, acabados, colores y equipos técnicos.

La oficina técnica está a su disposición para combinar nuestra gama de propuestas según sus necesidades!

*FR\_* Deagostini Inox propose à ses clients un service de design sur mesure.

Contactez notre bureau des ventes et demandez une proposition personnalisée concernant les produits, les finitions, les couleurs et les équipements techniques.

Le bureau technique est à votre disposition pour combiner notre gamme de propositions en fonction de vos besoins!



## Some examples



ART. TETRIS 35/B1/HOT55/ANG1

**Counter equipped with three 18/10-AISI 304 stainless steel chafing dish.** GN 1/1, depth mm 65. Glass lid with stainless steel frame and soft closure. Complete with electric plate with regulator.



*IT\_* Banco buffet equipaggiato con tre chafing dish in acciaio inossidabile 18/10-AISI 304. GN 1/1, profondità mm 65. Coperchio in vetro con cornice in acciaio inossidabile e chiusura ammortizzata. Completa di piastra elettrica con regolatore.

*ES\_* Isla buffet equipada de chafing dish en acero inoxidable 18/10-AISI 304. GN 1/1, profundidad mm 65. Tapa de vidrio con marco de acero inoxidable y cierre armonizado. Completo con placa eléctrica con regulador.

*FR\_* Comptoir buffet équipé de trois chafing dish en acier inoxydable 18/10-AISI 304. GN 1/1, profondeur mm 65. Couvercle en verre avec cadre en acier inoxydable et fermeture harmonisée. Complet avec plaque électrique avec régulateur.

colours available	matt finish	W1	B1	C2
	climb finish	W5	B2	C1
	ultra matt finish	W2	B6	C7
	wood finish	R1	Q1	A1
		E1	U1	

Optional

**Edge protection.**

*IT\_* Paraspigoli.

*ES\_* Protección para bordes.

*FR\_* Protection de bord.



## Some examples

### Counter equipped with 18/10-AISI 304 stainless steel heating plate.

Adjustable temperature from +30 to +90°C.  
6 GN 1/1 - cm 194x52 - 200W - 230V - 50/60Hz.



*IT\_* Banco buffet equipaggiato con piano caldo in acciaio inossidabile 18/10-AISI 304.

*ES\_* Isla buffet equipada de placa calentadora de acero inoxidable 18/10-AISI 304.

*FR\_* Comptoir buffet équipé de plateau chauffante en acier inoxydable 18/10-AISI 304.

colours available	matt finish	W1	B1	C2
	climb finish	W5	B2	C1
	ultra matt finish	W2	B6	C7
	wood finish	R1	Q1	A1
		E1	U1	



ART. TETRIS 34/Q1/HOT53/R200/Z1

#### Optionals

#### Polycarbonate protection with heating lamp.

*IT\_* Protezione in policarbonato con lampada riscaldante.

*ES\_* Protección de policarbonato con lámpara de calentamiento.

*FR\_* Protection en polycarbonate avec lampe chauffante.

#### Perimeter barrier.

*IT\_* Barriera perimetrale.

*ES\_* Barrera perimetral.

*FR\_* Barrière de périmètre.

## Some examples

### Counter equipped with induction glass-ceramic table top heat retaining unit.



*IT\_* Banco buffet equipaggiato con unità di mantenimento del calore ad induzione in vitroceramica.

*ES\_* Isla buffet equipada con unidad de mantenimiento de calor para inducción de vidriocerámica.

*FR\_* Comptoir buffet équipé de unité de chauffage par induction en vitrocéramique.



ART. TETRIS 34/C2/IND51/X1

colours available	matt finish	W1	B1	C2
	climb finish	W5	B2	C1
	ultra matt finish	W2	B6	C7
	wood finish	R1	Q1	A1
		E1	U1	

#### Optional

#### Neutral polycarbonate protection.

*IT\_* Protezione neutra in policarbonato.

*ES\_* Protección de policarbonato.

*FR\_* Protection neutre en polycarbonate.

### Some examples

#### Counter equipped with refrigerated 18/10-AISI 304 stainless steel basin.

Adjustable temperature from -5 to +8°C.  
6 GN 1/1 - cm 205x63 - depth cm 3 - 256W - 220V - 50Hz.



- IT\_* Banco buffet equipaggiato con vasca refrigerata in acciaio inossidabile 18/10-AISI 304.
- ES\_* Isla buffet equipada de cubeta refrigerada de acero inoxidable 18/10-AISI 304.
- FR\_* Comptoir buffet équipé de bac réfrigérée en acier inoxydable 18/10-AISI 304.



ART. TETRIS 34/B1/COL56

colours available	matt finish	W1	B1	C2
	climb finish	W5	B2	C1
	ultra matt finish	W2	B6	C7
	wood finish	R1	Q1	A1
		E1	U1	

### Some examples

#### Counter equipped with refrigerated 18/10-AISI 304 stainless steel basin.

Adjustable temperature from -5 to +8°C.  
6 GN 1/1 - cm 205x63 - depth cm 3 - 256W - 220V - 50Hz.



- IT\_* Banco buffet equipaggiato con vasca refrigerata in acciaio inossidabile 18/10-AISI 304.
- ES\_* Isla buffet equipada de cubeta refrigerada de acero inoxidable 18/10-AISI 304.
- FR\_* Comptoir buffet équipé de bac réfrigérée en acier inoxydable 18/10-AISI 304.



ART. TETRIS 34/B1/COL56/S/X1/ANG1

colours available	matt finish	W1	B1	C2
	climb finish	W5	B2	C1
	ultra matt finish	W2	B6	C7
	wood finish	R1	Q1	A1
		E1	U1	

#### Optionals

##### Reclining plates stand.

*IT\_* Scorripiatti reclinabile.

*ES\_* Pasaplatos reclinable.

*FR\_* Porte-assiettes rabattable.

##### Neutral polycarbonate protection.

*IT\_* Protezione neutra in policarbonato.

*ES\_* Protección de policarbonato.

*FR\_* Protection neutre en polycarbonate.

##### Edge protection.

*IT\_* Paraspigoli.

*ES\_* Protección para bordes.

*FR\_* Protection de bord.

### Some examples

#### Counter equipped with refrigerated 18/10-AISI 304 stainless steel basin.

Adjustable temperature from -5 to +8°C.  
GN 6/1 - cm 205x63 - 256W - 220V - 50Hz.



*IT\_* Banco buffet equipaggiato con vasca refrigerata in acciaio inossidabile 18/10-AISI 304.  
*ES\_* Isla buffet equipada de placa calentadora de acero inoxidable 18/10-AISI 304.  
*FR\_* Comptoir buffet équipé de bac réfrigérée en acier inoxydable 18/10-AISI 304.

colours available	matt finish	W1	B1	C2
	climb finish	W5	B2	C1
	ultra matt finish	W2	B6	C7
	wood finish	R1	Q1	A1
		E1	U1	



ART. TETRIS 34/Q1/COL56/X1

### Some examples

#### Counter equipped with two refrigerated glass-ceramic top.

Adjustable temperature from -5 to +15°C.  
2X2 GN 1/1-170W - 50/60Hz.



*IT\_* Banco buffet equipaggiato con due piani refrigerati in vetroceramica.  
*ES\_* Isla buffet equipada de dos placas refrigeradas de vidrio ceramica.  
*FR\_* Comptoir buffet équipé de deux plateaux réfrigéré en vitrocéramique.



ART. TETRIS 34/C2/COL54/COL54

colours available	matt finish	W1	B1	C2
	climb finish	W5	B2	C1
	ultra matt finish	W2	B6	C7
	wood finish	R1	Q1	A1
		E1	U1	

#### Optional

#### Neutral polycarbonate protection.

*IT\_* Protezione neutra in policarbonato.

*ES\_* Protección de policarbonato.

*FR\_* Protection neutre en polycarbonate.



## Some examples

**Counter equipped with two refrigerated glass-ceramic top.**  
Adjustable temperature from -5 to +15°C.



*IT\_* Banco buffet equipaggiato con due piani refrigerati in vetroceramica.  
*ES\_* Isla buffet equipado de tapas refrigerada de vidrio ceramica.  
*FR\_* Comptoir buffet équipé de deux plateaux réfrigéré en vitrocéramique.



ART. TETRIS 34/C2/COL54/COL54/X1

colours available	matt finish	W1	B1	C2
	climb finish	W5	B2	C1
	ultra matt finish	W2	B6	C7
	wood finish	R1	Q1	A1
		E1	U1	

### Optional

**Neutral polycarbonate protection.**

*IT\_* Protezione neutra in policarbonato.

*ES\_* Protección de policarbonato.

*FR\_* Protection neutre en polycarbonate.





ART. IDEA 51

### Neutral counter.

IT\_ Banco buffet neutro.  
 ES\_ Isla buffet neutra.  
 FR\_ Banco buffet neutro.

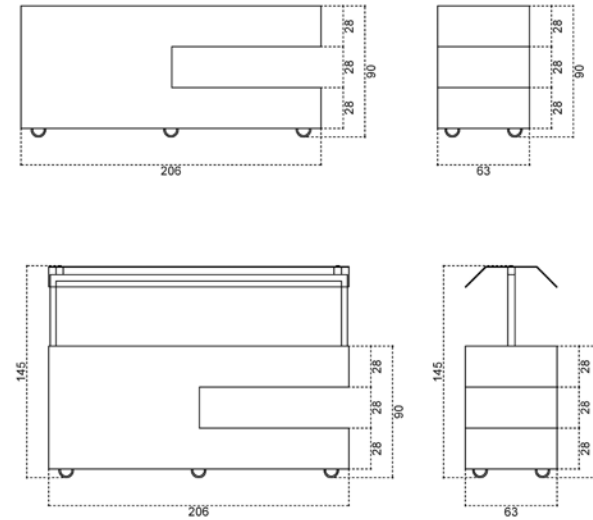

colours available	matt finish	W1	B1	C2
	climb finish	W5	B2	C1
	ultra matt finish	W2	B6	C7
	wood finish	R1	Q1	A1
		E1	U1	



ART. IDEA 52

### Neutral counter with 18/10-AISI 304 stainless steel top surface.

IT\_ Banco buffet neutro con piano in acciaio inossidabile 18/10-AISI 304.  
 ES\_ Isla buffet neutra con llano de acero inoxidable 18/10-AISI 304.  
 FR\_ Comptoir buffet neutre avec étagère en acier inoxydable 18/10-AISI 304.

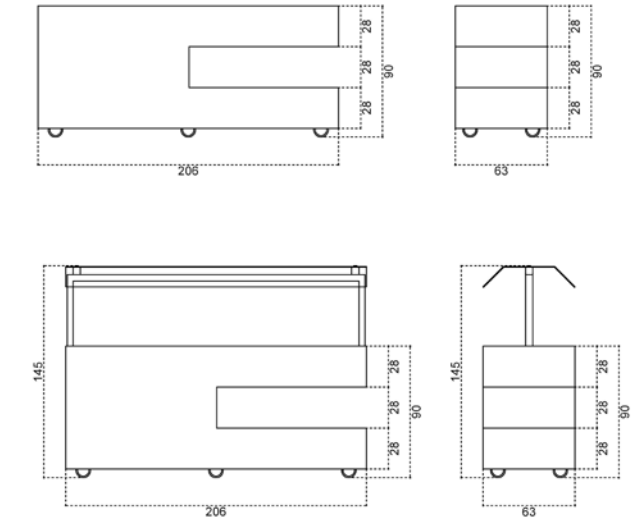

colours available	matt finish	W1	B1	C2
	climb finish	W5	B2	C1
	ultra matt finish	W2	B6	C7
	wood finish	R1	Q1	A1
		E1	U1	



### Some examples

**Counter equipped with three 18/10-AISI 304 stainless steel chafing dish.** GN 1/1, depth mm 65. Glass lid with stainless steel frame and soft closure. Complete with electric plate with regulator.



- IT\_* Banco buffet equipaggiato con tre chafing dish in acciaio inossidabile 18/10-AISI 304. GN 1/1, profondità mm 65. Coperchio in vetro con cornice in acciaio inossidabile e chiusura ammortizzata. Completa di piastra elettrica con regolatore.
- ES\_* Isla buffet equipada de chafing dish en acero inoxidable 18/10-AISI 304. GN 1/1, profundidad mm 65. Tapa de vidrio con marco de acero inoxidable y cierre armonizado. Completo con placa eléctrica con regulador.
- FR\_* Comptoir buffet équipé de trois chafing dish en acier inoxydable 18/10-AISI 304. GN 1/1, profondeur mm 65. Couvercle en verre avec cadre en acier inoxydable et fermeture harmonisée. Complet avec plaque électrique avec régulateur.



ART. IDEA 52/W1/HOT55

colours available	matt finish	W1	B1	C2
	climb finish	W5	B2	C1
	ultra matt finish	W2	B6	C7
	wood finish	R1	Q1	A1
		E1	U1	

### Some examples

**Counter equipped with refrigerated 18/10-AISI 304 stainless steel basin.** Adjustable temperature from -5 to +8°C. 6 GN 1/1 - cm 205X63 - depth cm 3 - 256W - 220V - 50Hz.



- IT\_* Banco buffet equipaggiato con vasca refrigerata in acciaio inossidabile 18/10-AISI 304.
- ES\_* Isla buffet equipada de placa calentadora de acero inoxidable 18/10-AISI 304.
- FR\_* Comptoir buffet équipé de bac réfrigérée en acier inoxydable 18/10-AISI 304.



ART. IDEA 51/E1/COL56

colours available	matt finish	W1	B1	C2
	climb finish	W5	B2	C1
	ultra matt finish	W2	B6	C7
	wood finish	R1	Q1	A1
		E1	U1	



Optional



**EN\_ Protective work surface panels that turn the buffet counter into a useful support surface.**

*IT\_ Pannelli per protezione piano di lavoro che trasformano il banco buffet in un utile piano d'appoggio.*

*ES\_ Tablas para la protección del llano de trabajo que vuelven el banco buffet en un llano de apoyo.*

*FR\_ Panneaux de protection des surfaces de travail qui transforment le comptoir buffet en une surface de support utile.*

## Some examples



ART. IDEA 51/R1/HOT53/Z1

### Counter equipped with 18/10-AISI 304 stainless steel heating plate.

Adjustable temperature from +30 to +90°C.

6 GN 1/1 - cm 194x52 - 200W - 230V - 50/60Hz.



*IT\_ Banco buffet equipaggiato con piano caldo in acciaio inossidabile 18/10-AISI 304.*

*ES\_ Isla buffet equipada de placa calentadora de acero inoxidable 18/10-AISI 304.*

*FR\_ Comptoir buffet équipé de plateau chauffante en acier inoxydable 18/10-AISI 304.*

colours available	matt finish		
	W1	B1	C2
	climb finish		
	W5	B2	C1
ultra matt finish			
W2	B6	C7	
wood finish			
R1	Q1	A1	
E1	U1		

Optional

**Polycarbonate protection with heating lamp.**

*IT\_ Protezione in policarbonato con lampada riscaldante.*

*ES\_ Protección de policarbonato con lámpara de calentamiento.*

*FR\_ Protection en polycarbonate avec lampe chauffante.*

## Some examples

### Counter equipped with 18/10-AISI 304 stainless steel heating plate.

Adjustable temperature from +30 to +90°C.  
6 GN 1/1 - cm 194x52 - 200W - 230V - 50/60Hz.



*IT\_* Banco buffet equipaggiato con piano caldo in acciaio inossidabile 18/10-AISI 304.

*ES\_* Isla buffet equipada de placa calentadora de acero inoxidable 18/10-AISI 304.

*FR\_* Comptoir buffet équipé de plateau chauffante en acier inoxydable 18/10-AISI 304.

### One column dishes elevator. Available heated (H) or neutral (N). Provided with lid and schuko socket.

*IT\_* Alzapiatti ad una colonna. Disponibile riscaldato (H) o neutro (N). Completo di coperchio e presa schuko.

*ES\_* Dispensador de platos con una columna. Disponible con calefacción (H) o neutro (N). Provisto de tapa y enchufe schuko.

*FR\_* Monte assiettes à une colonne. Disponible chauffé (H) ou neutre (N). Pourvu du couvercle et prise schuko.

top	size	cm 55x55x(h)88+22
	max cap.	kg 50
dish elevator	size	Ø cm 21/29
	max cap.	55 dishes max
	power	230V - 400W - Adjustable thermostat



ART. IDEA 51/R1/HOT53  
COMBINED WITH ART. 6007/C1/N

colours available	matt finish	W1	B1	C2
	climb finish	W5	B2	C1
	ultra matt finish	W2	B6	C7
	wood finish	R1	Q1	A1
E1		U1		







Plates holder: cm 90x30x(h)26

**1**  
Made in poplar wood, covered with 9/10 high pressure laminate panel.

*IT\_* Realizzata in legno di pioppo rivestito da un pannello di laminato ad alta pressione da 9/10.

*ES\_* Hecha en madera de álamo, cubierto por un panel de laminado alta presión 9/10.

*FR\_* Réalisée en bois de peuplier recouvert d'un panneau stratifié 9/10 haute pression.

**2**  
Details and appliances are made in brushed 18/10-AISI 304 stainless steel.

*IT\_* I dettagli e le applicazioni sono in acciaio inossidabile 18/10-AISI 304 satinato.

*ES\_* Los detalles están hecho de acero inoxidable 18/10-AISI 304 satinado.

*FR\_* Les détails et les applications sont en acier inoxydable 18/10-AISI304 satiné.

**3**  
Large table top and support for sliding plates.

*IT\_* Ampio piano d'appoggio e scorrimento dei piatti.

*ES\_* Amplio llano de apoyo y deslizar por platos.

*FR\_* Large plan d'appui et support pour les assiettes.

**4**  
6 non-marking, pivoting wheels with parking brake.

*IT\_* 6 ruote antiraccia, pivotanti e dotate di freno di stazionamento.

*ES\_* 6 ruedas antihuellas, rotatorias, con bloqueo incluido.

*FR\_* 6 roues pivotantes non marquantes équipées d'un frein de stationnement.

**5**  
Four plate-holding compartments carved into the structure.

*IT\_* Quattro vani porta piatti ricavati nella struttura.

*ES\_* Quatro repisas portaplatos empotrados en la estructura.

*FR\_* Quatre compartiments porte-assiettes gravés dans la structure.

Optionals



X2

*EN\_* Neutral tempered glass protection.

*IT\_* Protezione neutra in vetro temperato.

*ES\_* Protección neutra de vidrio templado.

*FR\_* Protection neutre en verre trempé.



Y2

*EN\_* Tempered glass protection with LED lighting.

*IT\_* Protezione in vetro temperato con illuminazione LED.

*ES\_* Protección de vidrio templado con iluminación LED.

*FR\_* Protection en verre trempé avec éclairage LED.



X1

*EN\_* Neutral polycarbonate protection.

*IT\_* Protezione neutra in polycarbonato.

*ES\_* Protección neutra de polycarbonato.

*FR\_* Protection neutre en polycarbonate.



Y1

*EN\_* Polycarbonate protection with LED lighting.

*IT\_* Protezione in polycarbonato con illuminazione LED.

*ES\_* Protección de polycarbonato con iluminación LED.

*FR\_* Protection en polycarbonate avec éclairage LED.



Z1

*EN\_* Polycarbonate protection with heating lamp.

*IT\_* Protezione in polycarbonato con lampada riscaldante.

*ES\_* Protección de polycarbonato con lámpara de calentamiento.

*FR\_* Protection en polycarbonate avec lampe chauffante.



## Some examples



ART. DOUBLE HOT/R1/B1/X1

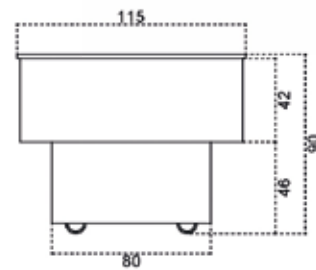
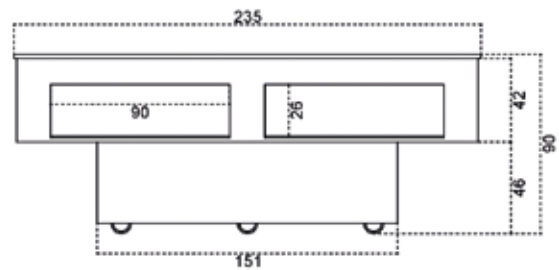
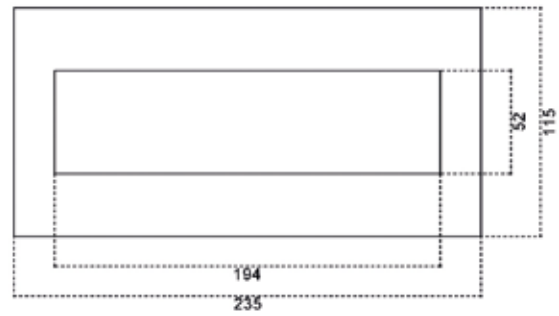

### Counter equipped with 18/10-AISI 304 stainless steel heating plate.

Adjustable temperature from +30 to +90°C.  
6 GN 1/1 - cm 194x52 - 200W - 230V - 50/60Hz.



*IT\_* Banco buffet equipaggiato con piano caldo in acciaio inossidabile 18/10-AISI 304.

*ES\_* Isla buffet equipada de placa calentadora de acero inoxidable 18/10-AISI 304.

*FR\_* Comptoir buffet équipé de plateau chauffante en acier inoxydable 18/10-AISI 304.



ART. DOUBLE HOT/R1/B1

#### Optional

**Neutral polycarbonate protection.**

*IT\_* Protezione neutra in polycarbonato.

*ES\_* Protección neutra de polycarbonato.

*FR\_* Protection neutre en polycarbonate.

colours available	matt finish		
	W1	B1	C2
	climb finish		
	W5	B2	C1
ultra matt finish			
W2	B6	C7	
wood finish			
R1	Q1	A1	
E1	U1		

## Some examples

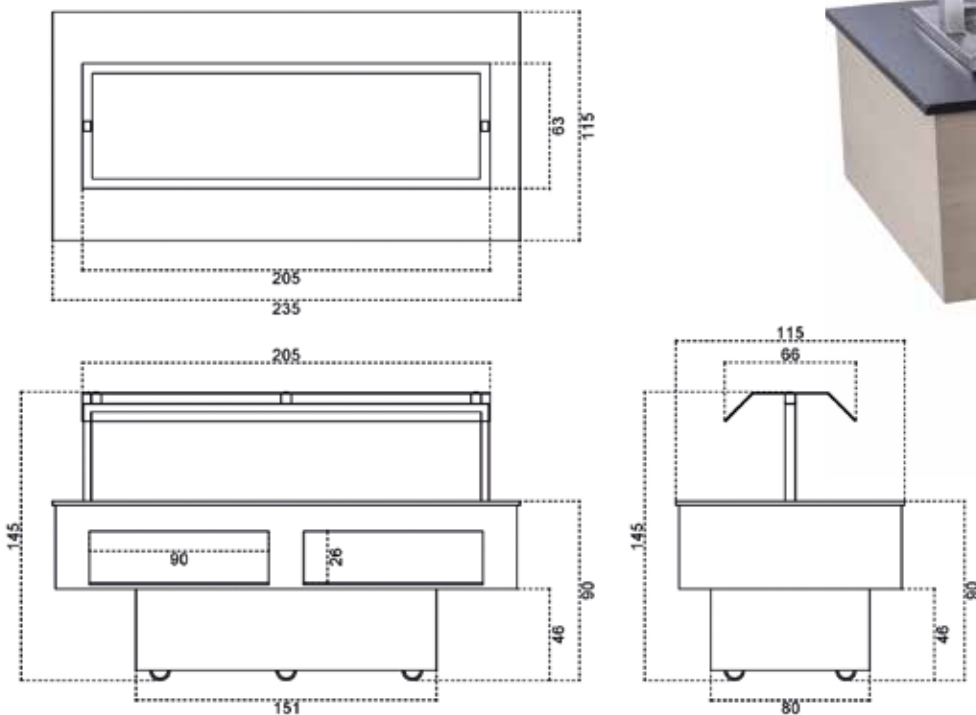

ART. DOUBLE COLD/R1/B1/X1

**Counter equipped with refrigerated 18/10-AISI 304 stainless steel basin.**  
 GN 6/1 - cm 205x63 - depth cm 3 - 256W - 220V - 50Hz.  
 Adjustable temperature from -5 to +8°C.



ART. DOUBLE COLD/R1/B1

*IT\_* Banco buffet equipaggiato con piano refrigerato in acciaio inossidabile 18/10-AISI 304.  
*ES\_* Isla buffet equipada de cubeta refrigerada de acero inoxidable 18/10-AISI 304.  
*FR\_* Comptoir buffet équipé de bac réfrigérée en acier inoxydable 18/10-AISI 304.

Optional

**Neutral polycarbonate protection.**

*IT\_* Protezione neutra in polycarbonato.

*ES\_* Protección neutra de polycarbonato.

*FR\_* Protection neutre en polycarbonate.



colours available		matt finish		
	W1	B1	C2	
colours available		climb finish		
	W5	B2	C1	
colours available		ultra matt finish		
	W2	B6	C7	
colours available		wood finish		
	R1	Q1	A1	
	E1	U1		



# dishes elevators



The dishes elevators represent the completion of the buffet counters and live cooking stations collections. Perfectly compatible, they can be made in all the colours and finishes available, so as to define a complete, refined and functional service.

*IT\_* I mobili alzapiatti rappresentano il completamento delle collezioni di banchi buffet e live cooking stations. Perfettamente compatibili, possono essere realizzati in tutte le varianti colore e finiture disponibili, così da definire un servizio completo, raffinato e funzionale.

*ES\_* Los levantaplatos representan la finalización de las colecciones de mesa de buffet y live cooking stations. Perfectamente compatibles, se pueden fabricar en todos los colores y acabados disponibles, a fin de definir un servicio completo, refinado y funcional.

*FR\_* Les porte vaisselle représentent l'achèvement des collections du comptoir buffet et live cooking stations. Parfaitement compatibles, ils peuvent être réalisés dans toutes les couleurs et finitions disponibles, afin de définir un service complet, raffiné et fonctionnel.





NEUTRAL

ART. 6007

HEATED

ART. 6008



**One column dishes elevator.**  
**Available heated (H) or neutral (N).**  
**Provided with lid and schuko socket.**

*IT\_* Alzapiatti ad una colonna. Disponibile riscaldato (H) o neutro (N). Completo di coperchio e presa schuko.

*ES\_* Dispensador de platos con una columna. Disponible con calefacción (H) o neutro (N). Provisto de tapa y enchufe schuko.

*FR\_* Monte assiettes à une colonne. Disponible chauffé (H) ou neutre (N). Pourvu du couvercle et prise schuko.

colours available	matt finish	W1	B1	C2
	climb finish	W5	B2	C1
	ultra matt finish	W2	B6	C7
	wood finish	R1	Q1	A1
		E1	U1	

top	size	cm 55x55x(h)88+22
	max cap.	kg 50
dish elevator	size	Ø cm 21/29
	max cap.	55 dishes max
	power	230V - 400W Adjustable thermostat



NEUTRAL

ART. 6011

HEATED

ART. 6010



**Two column dishes elevator.**  
**Available heated (H) or neutral (N).**  
**Provided with lid and schuko socket.**

*IT\_* Alzapiatti a due colonne. Disponibile riscaldato (H) o neutro (N). Completo di coperchio e presa schuko.

*ES\_* Dispensador de platos con dos columnas. Disponible con calefacción (H) o neutro (N). Provisto de tapa y enchufe schuko.

*FR\_* Monte assiettes à deux colonnes. Disponible chauffé (H) ou neutre (N). Pourvu du couvercle et prise schuko.

colours available	matt finish	W1	B1	C2
	climb finish	W5	B2	C1
	ultra matt finish	W2	B6	C7
	wood finish	R1	Q1	A1
		E1	U1	

top	size	cm 100x55x(h)88+22
	max cap.	kg 100
dish elevator	size	Ø cm 21/29
	max cap.	110 dishes max
	power	230V - 400W Adjustable thermostat



# live cooking & cocktail stations

Live cooking stations represent the turning point of Deagostini Inox. From 2005 until today we have been committed to improve each day a product characterized by innovative materials, latest generation technology, functional and modern design.

All manufactured in our factories, they are the guarantee of a Made in Italy product, that embodies all our professionalism and experience, from 1946 to today.

*IT\_* Le live cooking stations rappresentano il prodotto di svolta della Deagostini Inox. Dal 2005 ad oggi ci siamo impegnati a migliorare ogni giorno un prodotto caratterizzato da materiali innovativi, tecnologia di ultima generazione e design funzionale e moderno. Tutte realizzate presso i nostri stabilimenti, sono la garanzia di un prodotto Made in Italy, che racchiude tutta la nostra professionalità ed esperienza, dal 1946 ad oggi.

*ES\_* Las live cooking stations representan el punto de inflexión de Deagostini Inox. Desde 2005 hasta hoy nos hemos comprometido a mejorar cada día un producto caracterizado por materiales innovadores, tecnología de última generación y diseño funcional y moderno. Todos hechos en nuestras fábricas, son la garantía de un producto Made in Italy, que encarna todo nuestro profesionalismo y experiencia, desde 1946 hasta hoy.

*FR\_* Les live cooking stations représentent le point tournant de Deagostini Inox. De 2005 à aujourd'hui, nous nous sommes engagés à améliorer chaque jour un produit caractérisé par des matériaux innovants, une technologie de dernière génération et un design fonctionnel et moderne. Tous fabriqués dans nos usines, ils sont la garantie d'un produit Made in Italy, qui incarne tout notre professionnalisme et notre expérience de 1946 à nos jours.





## Functionality, Technology and Design.

### High pressure laminate - Layered

*IT\_* Laminato ad alta pressione - Multistrato

*ES\_* Laminado de alta presión - Multicapas

*FR\_* Stratifié haute pression - Multicouche

**EN\_ Revolution and innovation in an excellent material thanks to its functional and aesthetic potentialities. Anti-scratch, waterproof, resistant to oils, steam and water. Unalterable up to 60°, anti bacterial and long lasting.**

*IT\_* Rivoluzione ed innovazione in un materiale eccellente per le sue potenzialità funzionali ed estetiche. Anti-graffio, impermeabile, resiste ad oli, vapore ed acqua. Inalterabile fino a 60°, anti batterico e duraturo.

*ES\_* Revolución e innovación en un material excelente por sus potencialidades funcionales y estéticas. Anti-rasguños, impermeable, resistente a aceites, vapor y agua. Inalterable hasta 60°, antibacteriano y de larga duración.

*FR\_* Révolution et innovation dans un excellent matériau pour ses potentialités fonctionnelles et esthétiques. Anti-rayures, imperméable, résistant aux huiles, à la vapeur et à l'eau. Inaltérable jusqu'à 60°, anti bactérien et durable.

### Made of poplar wood covered with 9/10 high pressure laminate.

*IT\_* Realizzati in legno di pioppo rivestito da laminato ad alta pressione da 9/10.

*ES\_* Hechos en madera de álamo revestido de laminado de alta presión de 9/10.

*FR\_* Fabriqués en bois de peuplier recouvert de stratifié haute pression de 9/10.

### Worktop surface made with a 12 mm high pressure laminate panel.

*IT\_* Piano di lavoro realizzato con un pannello di laminato ad alta pressione da 12 mm.

*ES\_* Encimera realizada con un panel laminado de alta presión de 12 mm.

*FR\_* Plan de travail fabriqué avec un panneau stratifié haute pression de 12 mm.

### Equipped with 6 pivoting, non-marking wheels with brakes, to facilitate service maneuvers and storage.

*IT\_* Muniti di 6 ruote pivotanti, antiraccia e dotate di freno, per facilitare la manovre di servizio e stoccaggio.

*ES\_* Equipados con 6 ruedas rotatorias, antihuellas y con frenos, para facilitar las maniobras de servicio y almacenamiento.

*FR\_* Equipé de 6 roues pivotantes, non marquantes avec freins, pour faciliter les manœuvres d'entretien et stockage.

### Details and optionals made in 18/10-AISI 304 stainless steel.

*IT\_* Dettagli ed optionals realizzati in acciaio inossidabile 18/10-AISI 304.

*ES\_* Detalles y opcionales hecho en acero inoxidable 18/10-AISI 304.

*FR\_* Détails et optionals réalisée en acier inoxydable 18/10-AISI 304.

### Stainless steel 18/10-AISI 304 - Mirror finish

*IT\_* Acciaio inossidabile 18/10-AISI 304 - Lucidato a specchio

*ES\_* Acero inoxidable 18/10-AISI 304 - Acabado espejo

*FR\_* Acier inoxydable 18/10-AISI 304 - Poli miroir

**EN\_ 100% recyclable, long lasting and with mechanical features that ensure needless maintenance, corrosion resistance and sustainability. Bright finishes make details accurate and distinctive.**

*IT\_* 100% riciclabile, duraturo e con caratteristiche meccaniche di rilievo che garantiscono assenza di manutenzione, resistenza alla corrosione e durevolezza. Le finiture brillanti rendono i dettagli accurati e distintivi.

*ES\_* 100% reciclable, duradero y con características mecánicas de relevancia que aseguran el mantenimiento, la resistencia a la corrosión y la durabilidad. Los brillantes acabados hacen que los detalles sean precisos y distintivos.

*FR\_* 100% recyclable, durable et avec des caractéristiques mécaniques de relief qui assurent aucun entretien, résistance à la corrosion et durabilité. Les finitions brillantes rendent les détails précis et distinctifs.

### Live cooking stations can be customized with a wide range of colours available.

*IT\_* Le live cooking stations possono essere personalizzate con una vasta gamma di colori disponibili.

*ES\_* Live cooking stations se pueden personalizar con una amplia gama de colores disponibles.

*FR\_* Les live cooking stations peuvent être personnalisées avec une large gamme de couleurs disponibles.

finishes

#### MATT

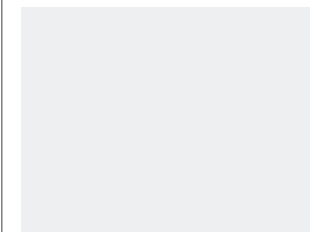

**W1**  
white ice

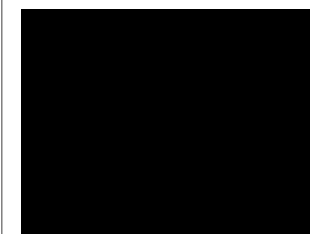

**B1**  
black



**C2**  
walkprint

#### CLIMB

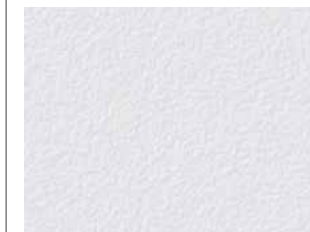

**W5**  
white climb

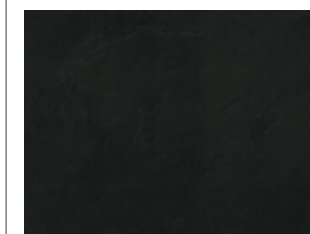

**B2**  
black ardesia



**C1**  
greige

#### MOD ULTRA MATT

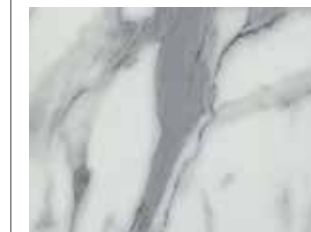

**W2**  
calacatta

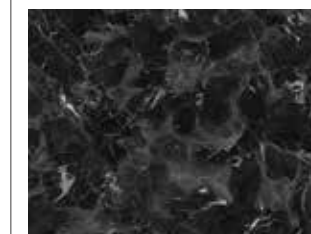

**B6**  
impero



**C7**  
navajo

#### WOOD



**R1**  
ash



**Q1**  
cherry rose



**A1**  
nancy elm



**E1**  
wengé congo



**U1**  
pearl elm

#### MIRROR



**G1**  
mirror gold



**S1**  
mirror silver



## Appliances



<b>DOM15</b>
cm 38x52 230V ~ 1P+N 50/60Hz
<b>EN_ Induction glass-ceramic hob - 1 cooking zone.</b>
<b>IT_ Piano cottura ad induzione in vetro temperato - 1 postazione di cottura.</b>
<b>ES_ Placa de inducción de vidrio templado - 1 área de cocción.</b>
<b>FR_ Plaque à induction en verre trempé - 1 zone de cuisson.</b>



<b>DOM26</b>
cm 30,2x52 220-240V / 50/60Hz
<b>EN_ Glass-ceramic hob - 2 cooking zones.</b>
<b>IT_ Piano cottura in vetroceramica - 2 postazioni di cottura.</b>
<b>ES_ Placa en vitrocerámica - 2 áreas de cocción.</b>
<b>FR_ Plaque en vitrocéramique - 2 zones de cuisson.</b>



<b>DOM10</b>
cm 29x51 230V~1P+N 50/60Hz
<b>EN_ Induction glass-ceramic hob - 2 cooking zones.</b>
<b>IT_ Piano cottura ad induzione in vitroceramica - 2 postazioni di cottura.</b>
<b>ES_ Placa de inducción en vitrocerámica - 2 áreas de cocción.</b>
<b>FR_ Plaque à induction en vitrocéramique - 2 zones de cuisson.</b>



<b>DOM25</b>
cm 30,2x52 220 - 240V 1N ~ / 3,7kW
<b>EN_ Induction glass-ceramic hob - 3 cooking zones.</b>
<b>IT_ Piano cottura ad induzione in vitroceramica - 3 postazioni di cottura.</b>
<b>ES_ Placa de inducción en vitrocerámica - 3 áreas de cocción.</b>
<b>FR_ Plaque à induction en vitrocéramique - 3 zones de cuisson.</b>

## Appliances



<b>DOM33</b>
cm 39x52 220 - 240V / 1,9kW
<b>EN_ TeppanYaki plate.</b>
<b>IT_ Piastra TeppanYaki.</b>
<b>ES_ Placa TeppanYaki.</b>
<b>FR_ Plaque TeppanYaki.</b>

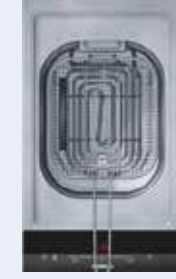

<b>DOM7</b>
cm 30x52 - lt 6 220 - 240V / 2,5kW
<b>EN_ Fryer.</b>
<b>IT_ Friggitrice.</b>
<b>ES_ Freidora.</b>
<b>FR_ Friteuse.</b>



<b>DOM5</b>
cm 39,2x52 220 - 240V / 3,4kW
<b>EN_ Lava stone grill plate.</b>
<b>IT_ Piastra grill a pietra lavica.</b>
<b>ES_ Placa grill de piedra de lava.</b>
<b>FR_ Plaque grill en pierre de lave.</b>



<b>DOM12</b>
cm 40x52 220-230V 50/60Hz
<b>EN_ Induction glass-ceramic wok hob.</b>
<b>IT_ Piano cottura ad induzione wok in vetro ceramica.</b>
<b>ES_ Encimera wok de inducción en vitrocerámica.</b>
<b>FR_ Table de cuisson wok à induction en vitrocéramique.</b>



<b>DOM28</b>
cm 60x52 220 - 240V 50/60Hz
<b>EN_ Induction glass-ceramic hob - 4 cooking zones.</b>
<b>IT_ Piano cottura ad induzione in vitroceramica - 4 postazioni di cottura.</b>
<b>ES_ Placa de inducción en vitrocerámica - 4 áreas de cocción.</b>
<b>FR_ Plaque à induction en vitrocéramique - 4 zones de cuisson.</b>



<b>DOM27</b>
cm 81x52 220 - 240V 50/60Hz
<b>EN_ Induction glass-ceramic hob - 6 cooking zones. Integrated extractor hood with cast iron grill. Max air expulsion capacity: 690 m³/h.</b>
<b>IT_ Piano cottura ad induzione in vitroceramica - 6 postazioni di cottura. Unità aspirante integrata con griglia in ghisa. Capacità max espulsione aria 690 m³/h.</b>
<b>ES_ Placa de inducción en vitrocerámica - 6 áreas de cocción. Campana extractora integrada con rejilla de hierro fundido. Capacidad máxima de expulsión de aire: 690 m³/h.</b>
<b>FR_ Plaque à induction en vitrocéramique - 6 zones de cuisson. Hotte aspirante intégrée avec grille en fonte. Capacité maximale d'expulsion d'air: 690 m³/h.</b>



<b>PRO16</b>
cm 33x53 GN1/1 400V Ø cm 30
<b>EN_ Induction wok hob.</b>
<b>IT_ Piano cottura ad induzione wok.</b>
<b>ES_ Encimera wok de inducción.</b>
<b>FR_ Table de cuisson wok à induction.</b>



<b>PRO1</b>
cm 32x53 230V 3800W
<b>EN_ Infrared glass-ceramic hob - 2 cooking zones.</b>
<b>IT_ Piano cottura ad infrarosso in vitroceramica - 2 postazioni di cottura.</b>
<b>ES_ Placa infrarrojo de vitrocerámica - 2 áreas de cocción.</b>
<b>FR_ Plaque à infrarouge en vitrocéramique - 2 zones de cuisson.</b>



<b>PRO15</b>
cm 33x53 GN 1/1 230V 3000W
<b>EN_ Induction glass-ceramic hob - 2 cooking zones.</b>
<b>IT_ Piano cottura ad induzione in vitroceramica - 2 postazioni di cottura.</b>
<b>ES_ Placa de inducción en vitrocerámica - 2 áreas de cocción.</b>
<b>FR_ Plaque à induction en vitrocéramique - 2 zones de cuisson.</b>



<b>PRO7</b>
cm 33x53 GN 1/1 230V 2400W
<b>EN_ Glass-ceramic hot maintenance plate. Maximum temperature +110°C.</b>
<b>IT_ Piano di mantenimento del caldo in vitroceramica. Temperatura massima +110°C.</b>
<b>ES_ Plan de conservación del calor en vitrocerámica. Temperatura máxima +110°C.</b>
<b>FR_ Plan de conservation de la chaleur en vitrocéramique. Température maximale +110°C.</b>

**EN\_ Appliances subject to the composition of the furniture.**

**IT\_ Applicazioni soggette alla composizione del mobile.**

**ES\_ Aplicaciones sujetas a la composición del mobiliario.**

**FR\_ Applications soumises à la composition du meuble.**

## Appliances



<b>PRO3</b>
cm 33x53 GN 1/1 230/400V 6000W
<b>EN_</b> Striped fry top. Maximum temperature +250°C.
<b>IT_</b> Fry top rigato. Temperatura massima +250°C.
<b>ES_</b> Placa fredora rayada. Temperatura máxima +250°C.
<b>FR_</b> Fry-top rayé. Température maximale +250°C.



<b>PRO6</b>
cm 33x53 GN 1/1 230V 3500W
<b>EN_</b> TeppanYaki plate. Temperature maximum +250°C.
<b>IT_</b> Piastra TeppanYaki. Maximum temperature +250°C.
<b>ES_</b> Placa TeppanYaki. Temperatura máxima +250°C.
<b>FR_</b> Plaque TeppanYaki. Température maximale +250°C.



<b>PRO10</b>
cm 33x53 - It 20 GN 1/1 230/400V 6000W
<b>EN_</b> Pasta cooker.
<b>IT_</b> Cuocipasta.
<b>ES_</b> Cocedor de pasta.
<b>FR_</b> Cuisneur à pâtes.



<b>PRO2</b>
cm 33x53 - It 9 GN 1/1 230/400V 4500-6000W
<b>EN_</b> Fryer.
<b>IT_</b> Friggitrice.
<b>ES_</b> Freidora.
<b>FR_</b> Friteuse.



<b>MIC1</b>
cm 60x50x(h)46 It 45 220-240V -50/60Hz
<b>EN_</b> Compact microwave oven.
<b>IT_</b> Forno compatto a microonde.
<b>ES_</b> Horno compacto microondas.
<b>FR_</b> Four à micro-ondes compact.



<b>G6</b>
GN 1/1 depth mm 60
<b>EN_</b> Basin.
<b>IT_</b> Vasca.
<b>ES_</b> Tanque.
<b>FR_</b> Baignoire.



<b>K90</b>
cm 91x35x(h)65-105 Max air expulsion capacity: 450 m³/h
<b>EN_</b> Extractor hood.
<b>IT_</b> Cappa ad espulsione.
<b>ES_</b> Campana extractora a expulsión.
<b>FR_</b> Hotte aspirante à expulsion.



<b>K52</b>
cm 10x52 Max air expulsion capacity: 540 m³/h
<b>EN_</b> Built-in extractor hood.
<b>IT_</b> Cappa integrata.
<b>ES_</b> Campana extractora incorporada.
<b>FR_</b> Hotte aspirante intégrée.



<b>FOR1</b>
cm 59,5x59,4x(h)54,8 It 71 220-240V / 3,6Kw
<b>EN_</b> Built-in oven.
<b>IT_</b> Forno ad incasso.
<b>ES_</b> Horno empotrado.
<b>FR_</b> Four intégré.



<b>LAV1</b>
cm 40x52 depth cm 20
<b>EN_</b> Sink with foldable mixer and swiveling spout.
<b>IT_</b> Lavabo con miscelatore abbattibile e canna girevole.
<b>ES_</b> Fregadero con batidora plegable y caño giratorio.
<b>FR_</b> Évier avec mélangeur pliant et bec pivotant.

## Optionals



<b>ANC1</b>
Ø cm 9 h cm 4,5
<b>EN_</b> Anchor hook.
<b>IT_</b> Gancio di ancoraggio.
<b>ES_</b> Gancho anclado.
<b>FR_</b> Crochet d'ancorage.



<b>P25</b>
cm 160
<b>EN_</b> Tempered glass protection.
<b>IT_</b> Protezione in vetro temperato.
<b>ES_</b> Protección de vidrio templado.
<b>FR_</b> Protection en verre trempé.



<b>P26</b>
cm 200
<b>EN_</b> Tempered glass protection.
<b>IT_</b> Protezione in vetro temperato.
<b>ES_</b> Protección de vidrio templado.
<b>FR_</b> Protection en verre trempé.



<b>X5</b>
cm 60 h cm 24
<b>EN_</b> Tempered glass and 18/10 stainless steel protection.
<b>IT_</b> Protezione in vetro temperato e acciaio inossidabile 18/10.
<b>ES_</b> Protección en vidrio templado y acero inoxidable 18/10.
<b>FR_</b> Protection en verre trempé et acier inoxydable 18/10.



<b>T25</b>
cm 66x25
<b>EN_</b> Wooden cut board.
<b>IT_</b> Tagliere in legno.
<b>ES_</b> Tabla de cortar de madera.
<b>FR_</b> Planche à découper en bois.



<b>T26</b>
cm 72x25
<b>EN_</b> Wooden cut board.
<b>IT_</b> Tagliere in legno.
<b>ES_</b> Tabla de cortar de madera.
<b>FR_</b> Planche à découper en bois.



# evolution



The “evolution” of the most classic Showcooking, revisited in a collection where design, functionality and technology come together to create a professional and dynamic cooking and cocktail stations.

Designed to meet all service requirements thanks to the large worktop surface and the latest generation appliances, it represents the best solution to every gastronomic event.

*IT\_* L’ “evoluzione” della più classica Showcooking, rivisitato in una collezione dove design, funzionalità e tecnologia si uniscono per creare postazioni cucina e bar professionali e dinamici. Realizzata per soddisfare tutte le esigenze di servizio grazie all’ampio piano di lavoro e alle applicazioni di ultima generazione, rappresenta la migliore soluzione ad ogni evento gastronomico.

*ES\_* La “evolución” de la más clásica Showcooking, revisado en una colección donde el design, la funcionalidad y la tecnología se unen para crear una cocina profesional y dinámica. Diseñado para satisfacer todos los requisitos de servicio gracias a la gran superficie de trabajo y las aplicaciones de última generación, representa la mejor solución para cada evento gastronómico.

*FR\_* L’ “évolution” de le plus classique Showcooking, revisité dans une collection où design, fonctionnalité et technologie se conjuguent pour créer postes de cuisine et bars professionnels et dynamiques. Conçu pour répondre à toutes les exigences de service grâce à la grande surface de travail et aux applications de dernière génération, il représente la meilleure solution pour chaque événement gastronomique.





**1**  
Sides and worktop surfaces in colour black ardesia, climb finish - B2.

**2**  
Working side in colour white matt - W1.

**3**  
Customizable front panel with a wide range of colours available.

*IT\_* Laterali e piani di lavoro in colore nero ardesia, finitura climb - B2.

*ES\_* Lateral y encimera en colores ardesia negra, acabado climb - B2.

*FR\_* Latéral et plans de travail en couleurs noir ardoise, finition climb - B2.

*IT\_* Lato di lavoro in colore bianco matt - W1.

*ES\_* Lado de trabajo en colores blanco matt - W1.

*FR\_* Côté de travail en couleurs blanc matt - W1.

*IT\_* Pannello frontale personalizzabile con una vasta gamma di colori disponibili.

*ES\_* Panel frontal personalizable con una amplia gama de colores disponibles.

*FR\_* Panneau frontal personnalisable avec une large gamme de couleurs disponible.



ART. EVOLUTION 60/R1

colours available	matt finish	W1	B1	C2
	climb finish	W5	B2	C1
	ultra matt finish	W2	B6	C7
	wood finish	R1	Q1	A1
		E1	U1	
mirror finish	G1	S1		

The four basic model can be customized by choosing from a wide range of appliances.

*IT\_* I quattro modelli base possono essere personalizzati scegliendo tra una vasta gamma di applicazioni.  
*ES\_* Los cuatro modelos básicos pueden personalizarse eligiendo entre una amplia gama de aplicaciones.  
*FR\_* Les quatre modèles de base peuvent être personnalisés en choisissant parmi une large gamme d'applications.

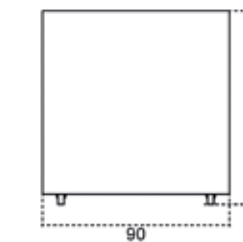
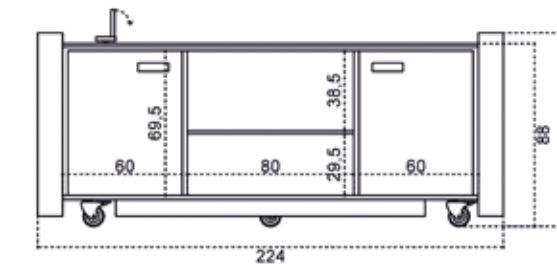
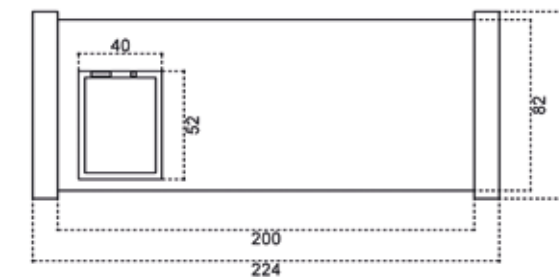

## Kitchen equipped with sink, induction glass-ceramic hob and TeppanYaki plate.



ART. EVOLUTION 60/W2/LAV1/DOM25/DOM33



BASIC MODEL: ART. EVOLUTION 60 **Appliances: see pages 116-119.**

EN\_ Live cooking station with two doors.

IT\_ Live cooking station con due ante.

ES\_ Live cooking station con dos puertas.

FR\_ Live cooking station avec deux portes.

## Some examples

IT\_ Cucina equipaggiata di lavandino, piano cottura ad induzione in vetro ceramica e piastra TeppanYaki.

ES\_ Cocina equipada con fregadero, placa de inducción en vitrocerámica y placa TeppanYaki.

FR\_ Cuisine équipée d'évier, plaque à induction en vitrocéramique et plaque TeppanYaki.

## Some examples

## Kitchen equipped with sink, induction glass-ceramic hob and TeppanYaki plate. Built-in refrigerator included.



ART. EVOLUTION 61/W2/LAV1/DOM25/DOM33

BASIC MODEL: ART. EVOLUTION 61 **Appliances: see pages 116-119.**

EN\_ Live cooking station with refrigerator.

IT\_ Live cooking station con frigorifero.

ES\_ Live cooking station con refrigerador.

FR\_ Live cooking station avec réfrigérateur.

IT\_ Cucina equipaggiata di lavandino, piano cottura ad induzione in vetro ceramica e piastra TeppanYaki. Frigorifero ad incasso incluso.

ES\_ Cocina equipada con placa de inducción en vitrocerámica y placa TeppanYaki. Refrigerador incorporado incluido.

FR\_ Cuisine équipée d'évier, plaque à induction en vitrocéramique et plaque TeppanYaki. Réfrigérateur intégré inclus.



## Kitchen equipped with sink, induction glass-ceramic hob and TeppanYaki plate. Built-in oven included.

Oven, 220-240V / 3,6Kw - lt 71.



ART. EVOLUTION 62/B6/LAV1/DOM25/DOM33



BASIC MODEL: ART. EVOLUTION 62 Appliances: see pages 116-119.

EN\_ Live cooking station with oven.

IT\_ Live cooking station con forno.

ES\_ Live cooking station con horno.

FR\_ Live cooking station avec four.

## Some examples

IT\_ Cucina equipaggiata di lavandino, piano cottura ad induzione in vetro ceramica e piastra TeppanYaki. Forno ad incasso incluso.

ES\_ Cocina equipada con fregadero, placa de inducción en vitrocerámica y placa TeppanYaki. Horno incorporado incluido.

FR\_ Cuisine équipée d'évier, plaque à induction en vitrocéramique et plaque TeppanYaki. Four intégré inclus.

## Some examples

## Kitchen equipped with sink, induction glass-ceramic hob and TeppanYaki plate. Built-in microwave oven included.

Microwave oven, 30 lt - 220-240V -50/60Hz.



ART. EVOLUTION 63/B6/LAV1/DOM25/DOM33



BASIC MODEL: ART. EVOLUTION 63 Appliances: see pages 116-119.

EN\_ Live cooking station with microwaves oven.

IT\_ Live cooking station con forno microonde.

ES\_ Live cooking station con horno de microondas.

FR\_ Live cooking station avec four à micro-ondes.





ART. LED1

**Multi-coloured LED strip equipped with remote control for surprising lighting effects during evening service.**

*IT\_* Striscia LED multicolore dotata di telecomando remoto per effetti luce sorprendenti durante il servizio serale.

*ES\_* Tira LED multicolor equipada con control remoto para efectos de iluminación sorprendentes durante el servicio nocturno.

*FR\_* Bande LED multicolore équipée d'une télécommande pour des effets de lumière surprenants pendant le service de nuit.

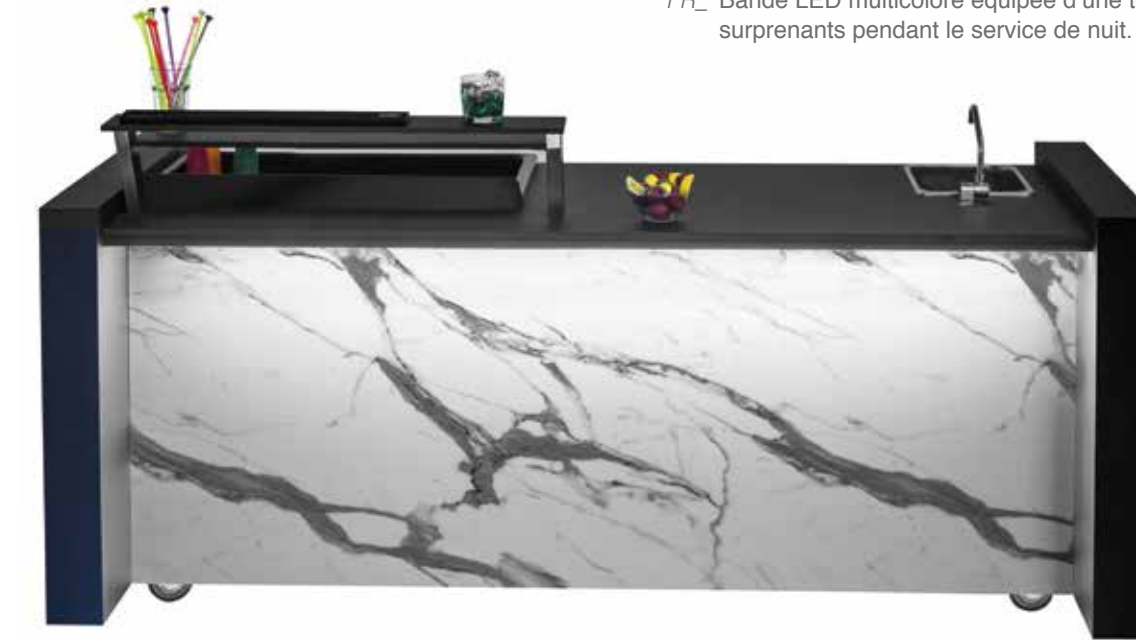

**5 colours in one led strips.**

*IT\_* 5 colori in un'unica striscia LED.

*ES\_* 5 colores en una sola tira de LED.

*FR\_* 5 couleurs dans une seule bande de LED.

led colours

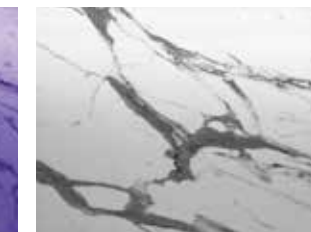
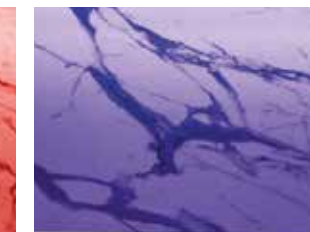
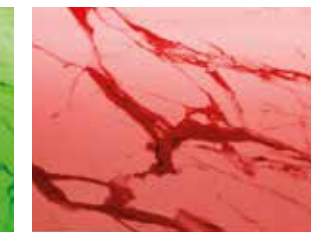
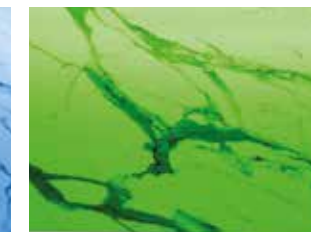



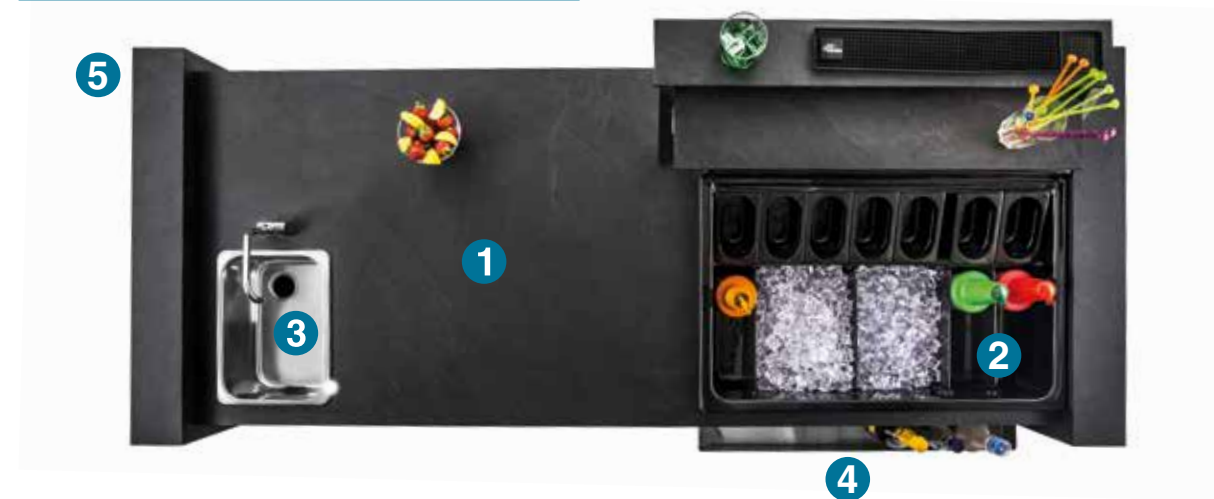

**1**  
Worktop surfaces made with a 12 mm high pressure laminate panel.

*IT\_* Piani di lavoro realizzati con un pannello di laminato ad alta pressione da 12 mm.

*ES\_* Llano de trabajo hecho con un panel laminado de alta presión de 12 mm.

*FR\_* Plan de travail réalisé avec un panneau stratifié haute pression de 12 mm.

**2**  
Professional bar basin.

*IT\_* Vasca cocktail professionale.

*ES\_* Cuenco de bar profesional.

*FR\_* Bassin de bar professionnel.

**3**  
18/10-AISI 304 stainless steel washbasin with foldable mixer and swiveling spout, cm 32x35.

*IT\_* Lavamani in acciaio inossidabile 18/10-AISI 304 con miscelatore abbattibile e canna girevole, cm 32x35.

*ES\_* Fregadero en acero inoxidable 18/10-AISI 304 con grifo plegable y caño giratorio, cm 32x35.

*FR\_* Évier en acier inoxydable 18/10-AISI 304 avec mélangeur pliable et bec pivotant, cm 32x35.

**4**  
Stainless steel 18/10 speed rack, cm 81x10x(h)9.

*IT\_* Speed rack in acciaio inossidabile 18/10, cm 81x10x(h)9.

*ES\_* Speed rack en acero inoxidable 18/10, cm 81x10x(h)9.

*FR\_* Speed rack en acier inoxydable 18/10, cm 81x10x(h)9.

**5**  
Equipped with 6 pivoting, non-marking wheels with brakes, to facilitate service maneuvers and storage.

*IT\_* Muniti di 6 ruote pivotanti, antitraccia e dotate di freno, per facilitare le manovre di servizio e stoccaggio.

*ES\_* Equipados con 6 ruedas rotatorias, antihuella y provista de frenos para facilitar las maniobras de servicio y almacenamiento.

*FR\_* Equipé de 6 roues pivotantes, non marquantes avec freins, pour faciliter les manoeuvres d'entretien et stockage.

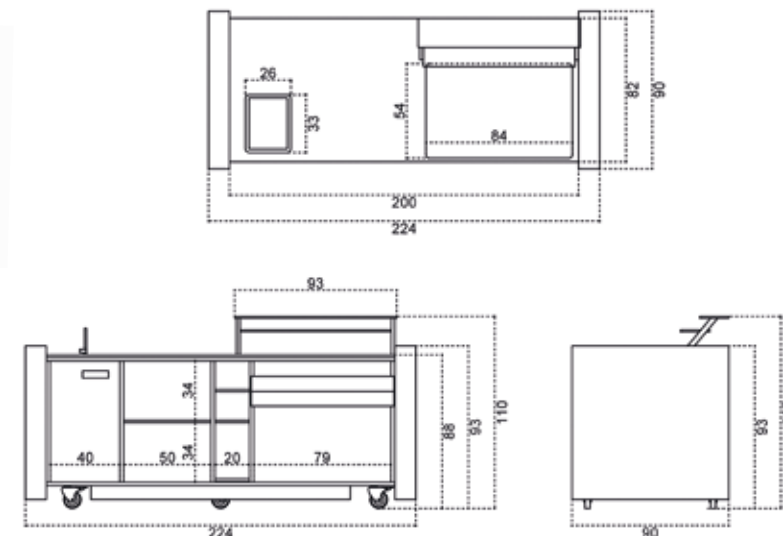

## Details



**EN\_ Professional bar basin. Ice capacity equal to 15 kg, with drainage system that can be connected to external piping. The basin, cm 37x84x(h)55, is divided into sectors by removable panels and includes: 7 trays with lid for gaskets, removable and resealable; 2 bottle and juice separators; 1 ice separator for cubes and crushed; 1 water and drain ice separator; 1 drain with gasket.**

*IT\_* Vasca per bar professionale. Capienza ghiaccio pari a 15 kg, con sistema di scolo collegabile alle tubazioni esterne. La vasca, cm 37x84x(h)55, è suddivisa in settori da pannelli removibili e comprende: 7 vaschette con coperchio per le guarnizioni, rimovibili e richiudibili; 2 separatori bottiglie e succhi; 1 separatore ghiaccio per cubetti e crushed; 1 separatore acqua e ghiaccio di scolo; 1 scarico con guarnizione.

*ES\_* Cuenco de bar profesional. Capacidad de hielo igual a 15 kg, que se puede conectar a la tubería externa. La cubeta, cm 37x84x(h)55, está dividida en sectores por paneles removibles y incluye: 7 bandejas con tapa para juntas, removibles y que se pueden volver a cerrar; 2 separadores para botellas y zumo; 1 separador de hielo para cubos y triturado; 1 separador de agua y drenaje de hielo; 1 desagüe con junta.

*FR\_* Baignoire de bar professionnel. Capacité de glace de 15 kg, avec système de drainage raccordable à la tuyauterie externe. Le bassin, cm 37x84x(h)55, est divisé en secteurs par des panneaux amovibles et comprend: 7 plateaux avec couvercle pour joints, amovibles et refermables; 2 séparateurs pour bouteilles et jus; 1 séparateur de glace pour les cubes et broyé; 1 séparateur d'eau et de glace de drainage; 1 drain avec joint.

**EN\_ Extractable glass holder.**

*IT\_* Portabicchieri estraibile.  
*ES\_* Portavasos extraíble.  
*FR\_* Porte-gobelets amovible.

**EN\_ Stainless steel 18/10-AISI 304 speed rack. cm 81x10x(h)9.**

*IT\_* Speed rack in acciaio inossidabile 18/10-AISI 304.  
*ES\_* Speed rack en acero inoxidable 18/10-AISI 304.  
*FR\_* Speed rack en acier inoxydable 18/10-AISI 304.



**EN\_ 18/10 stainless steel washbasin with foldable mixer and swiveling spout. Self powered. cm 32x35, depth mm 15.**

*IT\_* Lavamani in acciaio inossidabile 18/10 con miscelatore abbattibile e canna girevole. Autoalimentato.  
*ES\_* Fregadero en acero inoxidable 18/10 con grifo plegable y caño giratorio. Autoalimentable.  
*FR\_* Évier en acier inoxydable 18/10 avec mélangeur pliable et bec pivotant. Autoalimenté.



## Cocktail station equipped with professional instrumentation.



ART. EVOLUTION HAPPY HOURS 64/S1

*IT\_* Cocktail station fornita di strumentazione professionale.  
*ES\_* Estacion cocktail equipada con herramientas profesionales.  
*FR\_* Station de cocktails équipée d'instruments professionnels.

## Cocktail station equipped with professional instrumentation. Built-in refrigerator included. Refrigerator, lt 60 +10,2 - A+ - 230 Vac.



ART. EVOLUTION HAPPY HOURS 65/C2

*IT\_* Una cocktail station fornita di strumentazione professionale. Frigorifero incluso.  
*ES\_* Una estacion cocktail equipada con herramientas profesionales. Refrigerador incorporado.  
*FR\_* Une station de cocktails équipée d'instruments professionnels. Réfrigérateur intégré.





Modern and functional lines for a fully customizable kitchen. Original and modern, it is designed for those who need functionality and simplicity enclosed in innovative, lasting and last generation materials. Its versatility allows its use in, both, indoor and outdoor environments, such as terraces, gardens or poolside, making unique your catering and meeting. Equipped with a sliding top, useful support element and serving hatch, which, once closed becomes a furniture of design.

*IT\_* Linee moderne e funzionali per una cucina interamente personalizzabile. Originale e moderna è ideata per chi necessita di funzionalità e semplicità racchiuse in materiali innovativi, duraturi e di ultima generazione. La sua versatilità ne permette l'utilizzo sia in ambienti interni che esterni, come terrazze, giardini o bordi piscina, rendendo unici i vostri catering e meeting. Dotata di un piano scorrevole, utile elemento di appoggio o passavivande, una volta richiusa diventa un mobile d'arredo di design.

*ES\_* Líneas modernas y funcionales para una cocina totalmente personalizable. Original y moderna ha sido realizada para quien necesita funcionalidad y sencillez, envuelta en materiales innovativos, durable y de ultima generación. Su versatilidad permite un empleo, ambos, en el interior como en el exterior, fueran esos terrazas, jardines o bordes de piscinas, haciendo unicos su catering y meeting. Equipada con un plano corredizo, se convierte en un útil elemento de apoyo y pasacomidas, una vez repuesta, llega a ser un precioso mueble de design.

*FR\_* Lignes modernes et fonctionnelles pour une cuisine entièrement personnalisable. Original et moderne, il est conçu pour ceux qui ont besoin de fonctionnalité et de simplicité dans des matériaux innovants, durables et de dernière génération. Sa polyvalence lui permet d'être utilisé à l'intérieur et à l'extérieur, comme des terrasses, des jardins ou des bordures de piscine, rendant votre restauration et vos réunions uniques. Equipé d'un plateau coulissant, un élément de support utile ou une passerelle de service, une fois fermé, il devient un élément d'ameublement design.





**1**  
Made of poplar wood covered with 9/10 high pressure laminate.

*IT\_* Realizzati in legno di pioppo rivestito da laminato ad alta pressione da 9/10.

*ES\_* Hecho en madera de álamo revestido de laminado de alta presión de 9/10.

*FR\_* Fabriqués en bois de peuplier recouvert de stratifié haute pression de 9/10.

**2**  
Worktop surface made of 18/10-AISI 304 stainless steel.

*IT\_* Piano di lavoro realizzato in acciaio inossidabile 18/10-AISI 304.

*ES\_* Llano de trabajo realizado en acero inoxidable 18/10-AISI 304.

*FR\_* Plan de travail en acier inoxydable 18/10-AISI 304.

**3**  
Sliding top.

*IT\_* Piano scorrevole.

*ES\_* Llano corredizo.

*FR\_* Dessus coulissant.

**4**  
Equipped with 6 pivoting, non-marking wheels with brakes, to facilitate service maneuvers and storage.

*IT\_* Muniti di 6 ruote pivotanti, antitraccia e dotate di freno, per facilitare le manovre di servizio e stoccaggio.

*ES\_* Equipados con 6 ruedas rotatorias, antihuella y provista de frenos, para facilitar las maniobras de servicio y almacenamiento.

*FR\_* Equipé de 6 roues pivotates, non marquantes avec freins, pour faciliter les manoeuvres d'entretien ed stockage.



**Monocromatic: designed in a single colour version.**

*IT\_* Monocromatica: realizzata in un'unica variante colore.

*ES\_* Monocromatica: creada en una unica clase de color.

*FR\_* Monochromatique: réalisée dans une variante de couleur unique.



**Bicromatic: designed in two different colours.**

*IT\_* Bicromatica: realizzata con un massimo di due varianti colore.

*ES\_* Bicromatica: hecha en un maximo de dos diferentes colores.

*FR\_* Bichtomatique: réalisée avec un maximum de deux variantes de couleur.

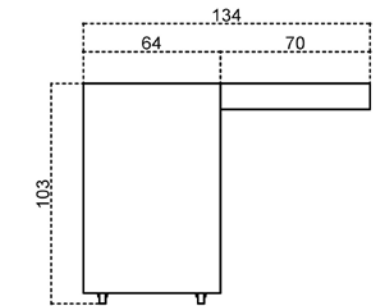
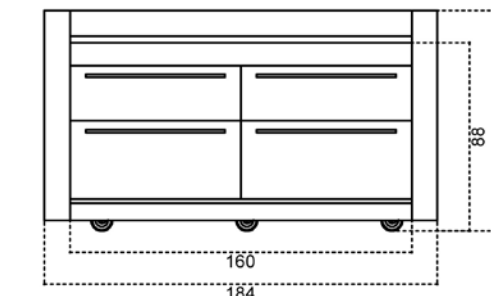
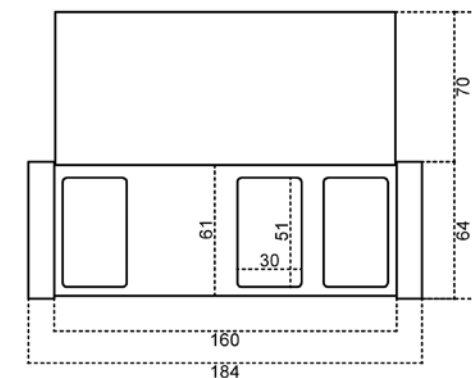



## Kitchen equipped with glass-ceramic hot maintenance plate, induction hob and lava stone grill plate.



ART. SHOWCOOKING 1/R1/E1/PROT/PRO15/DOM5

BASIC MODEL: ART. SHOWCOOKING 1 **Appliances: see pages 116-119.**

EN\_ Live cooking station with four drawers.

IT\_ Live cooking station con quattro cassetti.

ES\_ Live cooking station con cuatro cajones.

FR\_ Live cooking station avec quatre tiroirs.

IT\_ Cucina equipaggiata di piano di mantenimento del caldo, piano cottura a induzione in vitroceramica e piastra grill a pietra lavica.

ES\_ Cocina equipada por plan de conservación del calor, placa de inducción en vitrocerámica y placa grill de piedra de lava.

FR\_ Cuisine équipée de plan de conservation de la chaleur, plaque à induction en vitrocéramique et plaque grill en pierre de lave.

colours available	matt finish	W1	B1	C2
	climb finish	W5	B2	C1
	ultra matt finish	W2	B6	C7
	wood finish	R1	Q1	A1
		E1	U1	
	mirror finish	G1	S1	

## Some examples

## Some examples

## Kitchen equipped with lava stone grill plate, glass-ceramic hot maintenance plate and induction hob. Built-in oven included.

Oven, 220-240V / 3,6Kw - It 71.



ART. SHOWCOOKING 2/R1/E1/DOM5/PRO7/PRO15

BASIC MODEL: ART. SHOWCOOKING 2 **Appliances: see pages 116-119.**

EN\_ Live cooking station with oven.

IT\_ Live cooking station con forno.

ES\_ Live cooking station con horno.

FR\_ Live cooking station avec four.

IT\_ Cucina equipaggiata di piastra grill a pietra lavica, piano di mantenimento del caldo e piano cottura a induzione in vitroceramica. Forno a incasso incluso.

ES\_ Cocina equipada por placa grill de piedra de lava, plano de conservación del calor y placa de inducción en vitrocerámica. Horno empotrado incluido.

FR\_ Cuisine équipée de plaque grill en pierre de lave, plan de conservation de la chaleur et plaque à induction en vitrocéramique. Four encastré inclus.

colours available	matt finish	W1	B1	C2
	climb finish	W5	B2	C1
	ultra matt finish	W2	B6	C7
	wood finish	R1	Q1	A1
		E1	U1	
	mirror finish	G1	S1	

## Kitchen equipped with glass-ceramic hot maintenance plate and induction hob. Built-in refrigerator included. Refrigerator, It 60 +10,2 - A+ - 230 Vac.



ART. SHOWCOOKING 3/R1/E1/PRO7/PRO15

BASIC MODEL: ART. SHOWCOOKING 3 Appliances: see pages 116-119.

EN\_ Live cooking station with refrigerator. IT\_ Live cooking station con frigorifero. ES\_ Live cooking station con refrigerador. FR\_ Live cooking station avec réfrigérateur.

## Some examples

- IT\_ Cucina equipaggiata di piano di mantenimento del caldo e piano cottura ad induzione in vitroceramica. Frigorifero ad incasso incluso.  
 ES\_ Cocina equipada por plan de conservación del calor y placa de inducción en vitrocerámica. Refrigerador empotrado incluido.  
 FR\_ Cuisine équipée de plan de conservation de la chaleur et plaque à induction en vitrocéramique. Réfrigérateur encastré inclus.

colours available	matt finish	W1	B1	C2
	climb finish	W5	B2	C1
	ultra matt finish	W2	B6	C7
	wood finish	R1	Q1	A1
	mirror finish	E1	U1	
		G1	S1	

## Kitchen equipped with sink and one GN 1/1 basin, depth mm. 60. Built-in refrigerator included. Refrigerator, It 60 + 10,2 - A+ - 230 Vac.



ART. SHOWCOOKING OYSTER 4/Q1/B1

- IT\_ Cucina equipaggiata di lavandino e vasca GN 1/1, prof. mm 60. Frigorifero a incasso incluso.  
 ES\_ Cocina equipada por fregadero y tanque GN 1/1, prof. mm 60. Refrigerador incorporado incluido.  
 FR\_ Cuisine équipée d'évier et baignoire GN 1/1, prof. mm 60. Réfrigérateur intégré inclus.



EN\_ 18/10 stainless steel washbasin with foldable mixer and swiveling spout. Self powered. cm 32x35, depth mm 15.

IT\_ Lavamani in acciaio inossidabile 18/10 con miscelatore abbattibile e canna girevole. Autoalimentato.

ES\_ Fregadero en acero inoxidable 18/10 con grifo plegable y caño giratorio. Autoalimentable.

FR\_ Évier en acier inoxydable 18/10 avec mélangeur pliable et bec pivotant. Autoalimenté.

colours available	matt finish	W1	B1	C2
	climb finish	W5	B2	C1
	ultra matt finish	W2	B6	C7
	wood finish	R1	Q1	A1
	mirror finish	E1	U1	
		G1	S1	





## Details



**EN\_ Professional bar basin. Ice capacity equal to 15 kg, with drainage system that can be connected to external piping. The basin, cm 84x56x(h)37, is divided into sectors by removable panels and includes: 7 trays with lid for gaskets, removable and resealable; 2 bottles and juice separators; 1 ice separator for cubes and crushed; 1 water and drain ice separator; 1 drain with gasket.**

**IT\_ Vasca per bar professionale. Capienza ghiaccio pari a 15 kg, con sistema di scolo collegabile alle tubazioni esterne. La vasca, cm 84x56x(h)37, è suddivisa in settori da pannelli rimovibili e comprende: 7 vaschette con coperchio per le guarnizioni, rimovibili e richiudibili; 2 separatori bottiglie e succhi; 1 separatore ghiaccio per cubetti e crushed; 1 separatore acqua e ghiaccio di scolo; 1 scarico con guarnizione.**

**ES\_ Cuenco de bar profesional. Capacidad de hielo igual a 15 kg, que se puede conectar a la tubería externa. La cubeta, cm 84x56x(h)37, está dividida en sectores por paneles removibles y incluye: 7 bandejas con tapa para juntas, removibles y que se pueden volver a cerrar; 2 separadores para botellas y zumo; 1 separador de hielo para cubos y triturado; 1 separador de agua y drenaje de hielo; 1 desagüe con junta.**

**FR\_ Baignoire de bar professionnel. Capacité de glace de 15 kg, avec système de drainage raccordable à la tuyauterie externe. Le bassin, cm 84x56x(h)37, est divisé en secteurs par des panneaux amovibles et comprend: 7 plateaux avec couvercle pour joints, amovibles et refermables; 2 séparateurs pour bouteilles et jus; 1 séparateur de glace pour les cubes et broyé; 1 séparateur d'eau et de glace de drainage; 1 drain avec joint.**



**EN\_ Stainless steel 18/10 speed rack. cm 81x10x(h)9.**

**IT\_ Speed rack in acciaio inossidabile 18/10.**

**ES\_ Speed rack en acero inoxidable 18/10.**

**FR\_ Speed rack en acier inoxydable 18/10.**

## Cocktail station equipped with professional devices. Built-in refrigerator.

Refrigerator, It 60 +10,2 - A+ - 230 Vac.



ART. HAPPY HOURS 5/Q1/W1

IT\_ Una cocktail station fornita di attrezzatura professionale. Frigorifero incluso.  
 ES\_ Una estacion cocktail equipada conn herramientas profesionales. Refrigerador incorporado.  
 FR\_ Une station de cocktails équipée d'instruments professionnels. Réfrigérateur intégré.

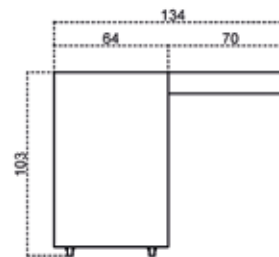
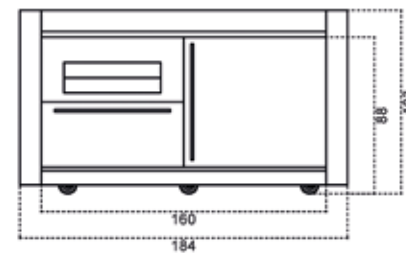
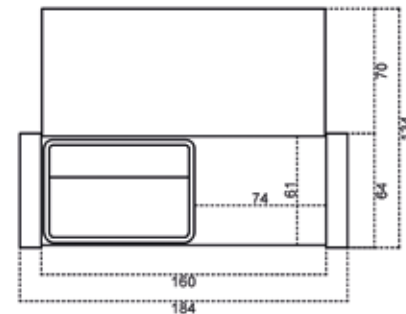

## Some examples

## Cocktail station equipped with professional devices. Built-in refrigerator.

Refrigerator, It 60 +10,2 - A+ - 230 Vac.



ART. HAPPY HOURS LUX 50/W1/B2

IT\_ Una cocktail station fornita di attrezzatura professionale. Frigorifero incluso.  
 ES\_ Una estacion cocktail equipada conn herramientas profesionales. Refrigerador incorporado.  
 FR\_ Une station de cocktails équipée d'instruments professionnels. Réfrigérateur intégré.

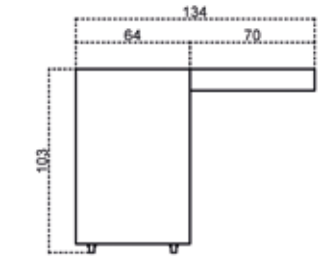
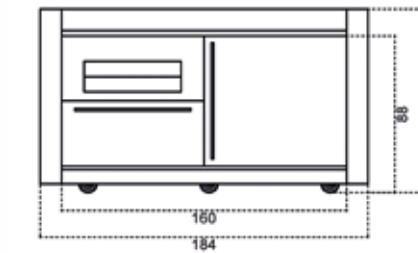
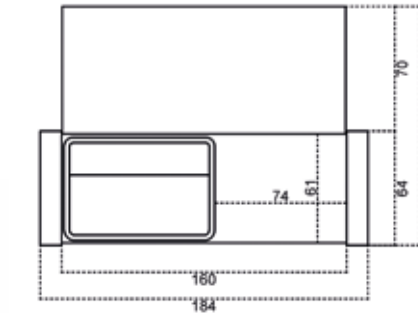





Linear and elegant shapes for a furniture that integrates all the functions of a professional kitchen in a small space. Fully customizable thanks to a wide range of latest generation appliances, colours and finishes.

With this collection, the kitchen unwinds from its classic walls to open up to terraces, gardens, halls and open spaces. The kitchen is hence available everywhere.

*IT\_* Forme lineari ed eleganti per un mobile che racchiude tutte le funzioni di una cucina professionale in un piccolo spazio. Totalmente personalizzabile grazie ad una vasta gamma di applicazioni di ultima generazione e numerosi colori e finiture. Con questa collezione, la cucina si disancora dalle sua classiche mura per aprirsi a terrazze, giardini, sale e spazi aperti. La cucina è così a disposizione ovunque.

*ES\_* Formas lineales y elegantes para un mueble que integra todas las funciones de una cocina profesional en un espacio pequeño. Totalmente personalizable gracias a una amplia gama de aplicaciones de última generación y numerosos colores y acabados. Con esta colección, la cocina se desenrolla desde sus paredes clásicas para abrirse a terrazas, jardines, salas y espacios abiertos. La cocina está así disponible en todas partes.

*FR\_* Des formes linéaires et élégantes pour un meuble qui intègre toutes les fonctions d'une cuisine professionnelle dans un espace réduit. Totalemtent personnalisable grâce à une vaste gamme d'applications de dernière génération et à de nombreuses couleurs et finitions. Avec cette collection, la cuisine se détend de ses murs classiques pour s'ouvrir sur des terrasses, des jardins, des halls et des espaces ouverts. La cuisine est tellement disponible partout.



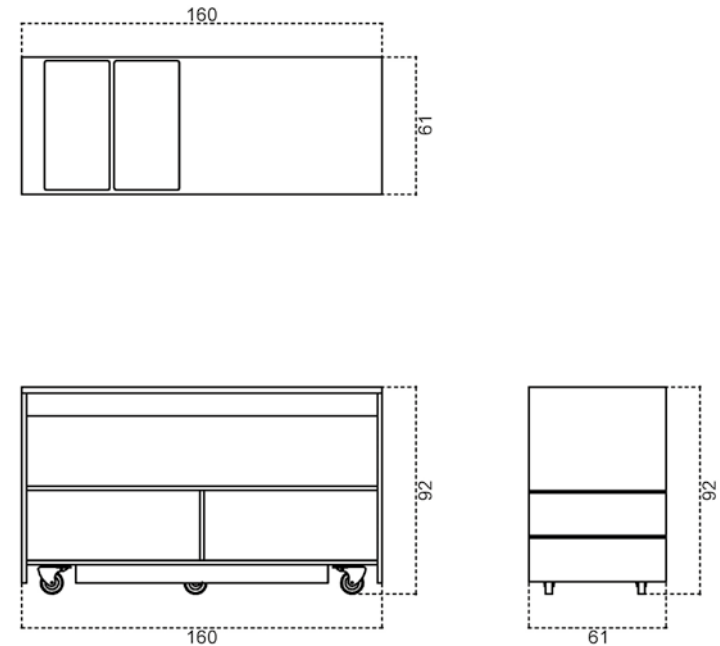

**1**  
Made of poplar wood covered with 9/10 high pressure laminate.

*IT\_* Realizzati in legno di pioppo rivestito da laminato ad alta pressione da 9/10.

*ES\_* Hecho en madera de álamo revestido de laminado de alta presión de 9/10.

*FR\_* Fabriqués en bois de peuplier recouvert de stratifié haute pression de 9/10.

**2**  
Worktop surface made of 18/10-AISI 304 stainless steel.

*IT\_* Piano di lavoro realizzato in acciaio inossidabile 18/10-AISI 304.

*ES\_* Llano de trabajo realizado en acero inoxidable 18/10-AISI 304.

*FR\_* Plan de travail en acier inoxydable 18/10-AISI 304.

**3**  
Equipped with 6 pivoting, non-marking wheels with brakes, to facilitate service maneuvers and storage.

*IT\_* Muniti di 6 ruote pivotanti, antitraccia e dotate di freno, per facilitare le manovre di servizio e stoccaggio.

*ES\_* Equipado con 6 ruedas rotatorias, antihuella y provista de frenos, para facilitar las maniobras de servicio y almacenamiento.

*FR\_* Equipé de 6 roues pivotates, non marquantes avec freins, pour faciliter les manoeuvres d'entretien ed stockage.

## Some examples

### Kitchen equipped with induction glass-ceramic hob and hot maintenance plate.



*IT\_* Cucina equipaggiata di piano cottura a induzione e piano di mantenimento del caldo in vitroceramica.

*ES\_* Cocina equipada de placa de inducción y plan de conservación del calor en vitrocerámica.

*FR\_* Cuisine équipée de plaque à induction et plan de conservation de la chaleur en vitrocéramique.



ART. CUBE 63/B1/DOM25/PRO7

**BASIC MODEL: ART. CUBE 63** Appliances: see pages 116-119.

*EN\_* Live cooking station with three glove compartments.

*IT\_* Live cooking station con tre vani portaoggetti.

*ES\_* Live cooking station con tres guanteras.

*FR\_* Live cooking station avec trois compartiments de rangement.

colours available	
matt finish	W1 B1 C2
climb finish	W5 B2 C1
ultra matt finish	W2 B6 C7
wood finish	R1 Q1 A1
	E1 U1
mirror finish	G1 S1



## Kitchen equipped with induction glass-ceramic hob and hot maintenance plate. Built-in refrigerator included.

Refrigerator, It 60 +10,2 - A+ - 230 Vac.



ART. CUBE 48/B1/DOM25/PRO7

BASIC MODEL: ART. CUBE 48 Appliances: see pages 116-119.

EN\_ Live cooking station with refrigerator.

IT\_ Live cooking station con frigorifero.

ES\_ Live cooking station con refrigerador.

FR\_ Live cooking station avec réfrigérateur.

## Some examples

IT\_ Cucina equipaggiata di piano cottura ad induzione e piano di mantenimento del caldo in vitroceramica. Frigorifero a incasso incluso.

ES\_ Cocina equipada de placa de inducción y plano de conservación del calor en vitrocerámica. Refrigerador incorporado incluido.

FR\_ Cuisine équipée de plaque à induction et plan de conservation de la chaleur en vitrocéramique. Réfrigérateur intégré inclus.

colours available	matt finish	W1	B1	C2
	climb finish	W5	B2	C1
	ultra matt finish	W2	B6	C7
	wood finish	R1	Q1	A1
		E1	U1	
	mirror finish	G1	S1	

## Some examples

## Kitchen equipped with extractor hood and two induction glass-ceramic hob.



ART. CUBE 49/E1/K90/DOM10/DOM10

BASIC MODEL: ART. CUBE 49 Appliances: see pages 116-119.

EN\_ Live cooking station with three doors.

IT\_ Live cooking station con tre ante.

ES\_ Live cooking station con tres puertas.

FR\_ Live cooking station avec trois portes.

colours available	matt finish	W1	B1	C2
	climb finish	W5	B2	C1
	ultra matt finish	W2	B6	C7
	wood finish	R1	Q1	A1
		E1	U1	
	mirror finish	G1	S1	



Details



**EN\_ Two removable refrigerated drawers for easy cleaning. Equipped with soft closing.**  
*IT\_* Due cassetti refrigerati ed estraibili per facilitare la pulizia. Equipaggiati di chiusura ammortizzata.  
*ES\_* Dos cajones refrigerados y extraíbles para facilitar la limpieza. Equipados con cierre suave.  
*FR\_* Deux tiroir réfrigérés et amovibles pour un nettoyage facile. Équipé avec fermeture en douceur.



**EN\_ Refrigerator with 18/10 stainless steel top and LED backlight.**  
*IT\_* Frigorifero con piano in acciaio inossidabile 18/10 e retroilluminazione a LED.  
*ES\_* Frigorífico con tapa de acero inoxidable 18/10 y retroiluminación LED.  
*FR\_* Réfrigérateur avec dessus en acier inoxydable 18/10 et rétroéclairage LED.



**EN\_ 18/10 stainless steel speed rack. cm 81x10x(h)9.**  
*IT\_* Speed rack in acciaio inossidabile 18/10.  
*ES\_* Speed rack en acero inoxidable 18/10.  
*FR\_* Speed rack en acier inoxydable 18/10.



**EN\_ Professional bar basin. Ice capacity equal to 15 kg, with drainage system that can be connected to external piping. The basin, cm 84x56x(h)37, is divided into sectors by removable panels and includes: 7 trays with lid for gaskets, removable and resealable; 2 bottle and juice separators; 1 ice separator for cubes and crushed; 1 water and drain ice separator; 1 drain with gasket.**  
*IT\_* Vasca per bar professionale. Capienza ghiaccio pari a 15 kg, con sistema di scolo collegabile alle tubazioni esterne. La vasca, cm 84x56x(h)37, è suddivisa in settori da pannelli removibili e comprende: 7 vaschette con coperchio per le guarnizioni, rimovibili e richiudibili; 2 separatori bottiglie e succhi; 1 separatore ghiaccio per cubetti e crushed; 1 separatore acqua e ghiaccio di scolo; 1 scarico con guarnizione.  
*ES\_* Cuenco de bar profesional. Capacidad de hielo igual a 15 kg, que se puede conectar a la tubería externa. La cubeta, cm 84x56x(h)37, está dividida en sectores por paneles removibles y incluye: 7 bandejas con tapa para juntas, removibles y que se pueden volver a cerrar; 2 separadores para botellas y zumo; 1 separador de hielo para cubos y triturado; 1 separador de agua y drenaje de hielo; 1 desagüe con junta.  
*FR\_* Baignoire de bar professionnel. Capacité de glace de 15 kg, avec système de drainage raccordable à la tuyauterie externe. Le bassin, cm 84x56x(h)37, est divisé en secteurs par des panneaux amovibles et comprend: 7 plateaux avec couvercle pour joints, amovibles et refermables; 2 séparateurs pour bouteilles et jus; 1 séparateur de glace pour les cubes et broyé; 1 séparateur d'eau et de glace de drainage; 1 drain avec joint.

## Cocktail station equipped with professional instrumentation.



ART. CUBE HAPPY HOURS 42/W1/B1

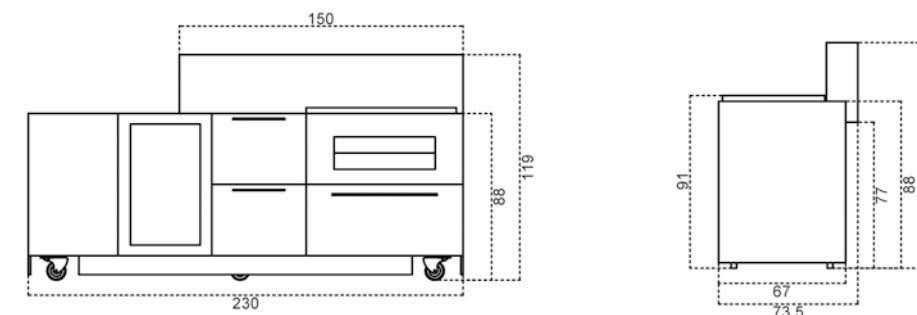

colours available	
matt finish	W1 B1 C2
climb finish	W5 B2 C1
ultra matt finish	W2 B6 C7
wood finish	R1 Q1 A1
	E1 U1
mirror finish	G1 S1



# new cube



The clean shapes of the Cube collection evolve to create a new design, while retaining the functionality and specialization of a professional kitchen. Thus was born NewCube.

*IT\_* Le linee pulite della collezione Cube si evolvono per creare un nuovo design, pur conservando la funzionalità e la specializzazione di una cucina professionale. Nasce così NewCube.

*ES\_* Las líneas limpias de la colección Cube se desarrollan para crear un nuevo design, aun conservando la funcionalidad y la especialización de una cocina profesional. Así nace NewCube.

*FR\_* Les lignes épurées de la collection Cube évoluent pour créer un nouveau design, tout en conservant les fonctionnalités et la spécialisation d'une cuisine professionnelle. Ainsi est né NewCube.

**Monocromatic: designed in a single colour version.**

*IT\_* Monocromatica: realizzata in un'unica variante colore.

*ES\_* Monocromatica: creada en una unica clase de color.

*FR\_* Monochromatique: réalisée dans une variante de couleur unique.



ART. NEW CUBE 120



ART. NEW CUBE 160

**EN\_ The NewCube\_Kitchen collection can be made in two sizes.**

*IT\_* La collezione NewCube\_Kitchen può essere realizzata in due misure.

*ES\_* La colección NewCube\_Kitchen puede ser creada en dos diferentes medidas.

*FR\_* La collection NewCube\_Kitchen peut être réalisée en deux tailles.

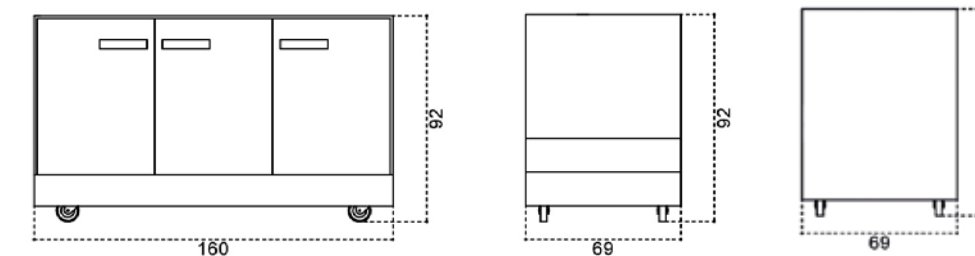
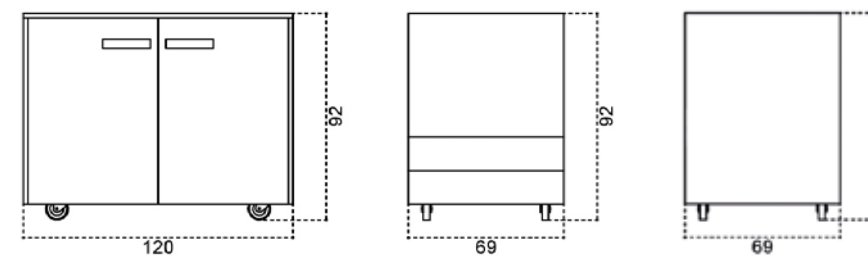

**Bicromatic: designed in two different colours.**

*IT\_* Bicromatica: realizzata con un massimo di due varianti colore.

*ES\_* Bicromatica: hecha en un maximo de dos diferentes colores.

*FR\_* Bichromatique: réalisée avec un maximum de deux variantes de couleur.



ART. NEW CUBE 120F



ART. NEW CUBE 160F



ART. NEW CUBE 120F



ART. NEW CUBE 160F



## Kitchen equipped with sink.

Sink, cm 40x52x(h)20 - lt 22.



ART. NEW CUBE 120/W5/LAV1

colours available	matt finish	W1	B1	C2
	climb finish	W5	B2	C1
	ultra matt finish	W2	B6	C7
	wood finish	R1	Q1	A1
		E1	U1	
	mirror finish	G1	S1	

BASIC MODEL: ART. NEW CUBE 120 **Appliances: see pages 116-119.**

EN\_ Live cooking station with two doors. IT\_ Live cooking station con due ante. ES\_ Live cooking station con dos puertas. FR\_ Live cooking station avec deux portes.

## Some examples

IT\_ Cucina equipaggiata di lavandino.  
ES\_ Cocina equipada con fregadero.  
FR\_ Cuisine équipée avec évier.

## Some examples

## Kitchen equipped with sink and glass-ceramic induction hob.

Sink, cm 40x52x(h)20 - lt 22.

Induction hob, cm 80x40 - 230V - 1,5kW.



ART. NEW CUBE 120F/W5/R1/LAV1/DOM25

IT\_ Cucina equipaggiata di lavandino e piano a induzione in vetroceramica.  
ES\_ Cocina equipada con un fregadero y placa à inducción de vidriocerámica.  
FR\_ Cuisine équipée d'un évier et plaque à induction en vitrocéramique.

colours available	matt finish	W1	B1	C2
	climb finish	W5	B2	C1
	ultra matt finish	W2	B6	C7
	wood finish	R1	Q1	A1
		E1	U1	
	mirror finish	G1	S1	

BASIC MODEL: ART. NEW CUBE 120F **Appliances: see pages 116-119.**

EN\_ Live cooking station with two doors. IT\_ Live cooking station con due ante. ES\_ Live cooking station con dos puertas. FR\_ Live cooking station avec deux portes.

## Kitchen equipped with glass-ceramic induction hob.

Induction hob, cm 80x40 - 230V - 1,5kW.



ART. NEW CUBE 120F/W5/G1/DOM15

BASIC MODEL: ART. NEW CUBE 120F **Appliances: see pages 116-119.**

EN\_ Live cooking station with two doors. IT\_ Live cooking station con due ante. ES\_ Live cooking station con dos puertas. FR\_ Live cooking station avec deux portes.

## Some examples

IT\_ Cucina equipaggiata di piano ad induzione in vetroceramica.  
 ES\_ Cocina equipada con placa inducción de vidrioocerámica.  
 FR\_ Cuisine équipée d'une plaque à induction en vitrocéramique.

colours available	matt finish	W1	B1	C2
	climb finish	W5	B2	C1
	ultra matt finish	W2	B6	C7
	wood finish	R1	Q1	A1
		E1	U1	
	mirror finish	G1	S1	

## Some examples

## Kitchen equipped with two glass-ceramic induction hobs and telescopic hood integrated in the worktop.

Induction hob, cm 80x40 - 230V - 1,5kW. Built-in extractor hood, cm 10x52 - Max air expulsion capacity: 540 m<sup>3</sup>/h.



ART. NEW CUBE 160F/B2/S1/DOM25/DOM25/K52

BASIC MODEL: ART. NEW CUBE 160F **Appliances: see pages 116-119.**

EN\_ Live cooking station with three doors. IT\_ Live cooking station con tre ante. ES\_ Live cooking station con tres puertas. FR\_ Live cooking station avec trois portes.

IT\_ Cucina equipaggiata di due piani ad induzione in vetroceramica e cappa telescopica integrata nel piano di lavoro.  
 ES\_ Cocina equipada con dos placas a inducción de vidrioocerámica y capota telescópica integrada en la encimera.  
 FR\_ Cuisine équipée de deux plaques à induction en vitrocéramique et hotte télescopique intégrée au plan de travail.

colours available	matt finish	W1	B1	C2
	climb finish	W5	B2	C1
	ultra matt finish	W2	B6	C7
	wood finish	R1	Q1	A1
		E1	U1	
	mirror finish	G1	S1	







**All counters can be equipped with a wide range of latest generation appliances.**



*IT\_* I banchi buffet possono essere attrezzati con una vasta gamma di applicazioni di ultima generazione.

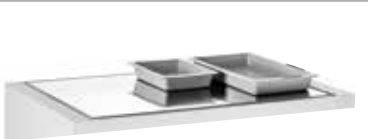

*ES\_* Los mostradores de buffet pueden equiparse con una amplia gama de aplicaciones de última generación.

*FR\_* Les comptoirs de buffets peuvent être équipés avec une large gamme d'applications de dernière génération.

HOT MAINTENANCE	Appliances	Code	Description				Technical info	cm 120x69x(h)93	cm 160x69x(h)93
		IND51	<i>EN_</i> Induction glass-ceramic tabletop heat-retaining unit. Remote control.	<i>IT_</i> Unità di mantenimento del calore ad induzione in vetroceramica. Comando remoto.	<i>ES_</i> Unidad de mantenimiento de calor por inducción de vitrocerámica. Comando a distancia.	<i>FR_</i> Unité de chauffage par induction en vitrocéramique. Commande à distance.	cm 80x40  230V - 1,5kW	●	●
	HOT52	<i>EN_</i> 18/10-AISI 304 stainless steel heating plate. Adjustable temperature from +30 to +90°C. Remote control.	<i>IT_</i> Piano caldo in acciaio inossidabile 18/10-AISI 304. Temperatura regolabile da +30 a +90°C. Comando remoto.	<i>ES_</i> Placa calentadora en acero inoxidable 18/10-AISI 304. Temperatura regulable de +30 a +90°C. Comando a distancia.	<i>FR_</i> Plateau chauffante en acier inoxydable 18/10-AISI 304. Température réglable de +30 à +90°C. Commande à distance.	2 GN 1/1 cm 69x62  600W - 230V - 50/60Hz	●	●	
	HOT59	<i>EN_</i> Tempered glass heating plate with two individually adjustable thermostats.	<i>IT_</i> Piano caldo in vetro temperato con due termostati indipendenti.	<i>ES_</i> Placa calentadora de vidrio templado con dos termostatos ajustables individualmente.	<i>FR_</i> Plateau chauffante en verre trempé avec deux thermostats à réglage individuel. Commande à distance.	2 GN 1/1 cm 69x58  600W - 230V - 50/60Hz	●	●	
	HOT60	<i>EN_</i> 18/10-AISI 304 stainless steel heating plate. Adjustable temperature from +30 to +90°C. Remote control.	<i>IT_</i> Piano caldo in acciaio inossidabile 18/10-AISI 304. Temperatura regolabile da +30 a +90°C. Comando remoto.	<i>ES_</i> Placa calentadora en acero inoxidable 18/10-AISI 304. Temperatura regulable de +30 a +90°C. Comando a distancia.	<i>FR_</i> Plateau chauffante en acier inoxydable 18/10-AISI 304. Température réglable de +30 à +90°C. Commande à distance.	4 GN 1/1 103x64(h)4  1200W - 230V - 50/60Hz	●	●	

ICE BASINS	Appliances	Code	Description				Technical info	cm 120x69x(h)93	cm 160x69x(h)93
		ICE57	<i>EN_</i> 18/10-AISI 304 stainless steel ice basin.	<i>IT_</i> Vasca per ghiaccio in acciaio inossidabile 18/10-AISI 304.	<i>ES_</i> Cubeta para hielo en acero inoxidable 18/10-AISI 304.	<i>FR_</i> Bac à glace en acier inoxydable 18/10-AISI 304.	2 GN 1/1 cm 41x62 depth cm 10,9	●	●
	ICE58	<i>EN_</i> 18/10-AISI 304 stainless steel ice basin.	<i>IT_</i> Vasca per ghiaccio in acciaio inossidabile 18/10-AISI 304.	<i>ES_</i> Cubeta para hielo en acero inoxidable 18/10-AISI 304.	<i>FR_</i> Bac à glace en acier inoxydable 18/10-AISI 304.	3 GN 1/1 cm 106x62 depth cm 10,9	●	●	

COLD MAINTENANCE	Appliances	Code	Description				Technical info	cm 120x69x(h)93	cm 160x69x(h)93
		COL54	<i>EN_</i> Refrigerated glass-ceramic top. Adjustable temperature from -5 to +15°C.	<i>IT_</i> Piano refrigerato in vitroceramica. Temperatura regolabile da -5 a +15°C.	<i>ES_</i> Tapa de vidrio ceramica refrigerada. Temperatura regulable de -5 a +15°C.	<i>FR_</i> Plateau en vitrocéramique réfrigéré. Température réglable de -5 à +15°C.	2 GN 1/1 cm 53x66  170W - 50/60Hz	●	●
	COL55	<i>EN_</i> Refrigerated 18/10-AISI 304 stainless steel basin. Remote control.	<i>IT_</i> Vasca refrigerata in acciaio inossidabile 18/10-AISI 304. Comando remoto.	<i>ES_</i> Cubeta refrigerada de acero inoxidable 18/10-AISI 304. Comando a distancia.	<i>FR_</i> Bac réfrigérée en acier inoxydable 18/10-AISI 304. Commande à distance.	3 GN 1/1 cm 106x62  350W	●	●	

PROTECTIONS	Optionals	Code	Description				Technical info	cm 120x69x(h)93	cm 160x69x(h)93
		X3	<i>EN_</i> Neutral polycarbonate protection.	<i>IT_</i> Protezione neutra in polycarbonato.	<i>ES_</i> Protección neutra de policarbonato.	<i>FR_</i> Protection neutre en polycarbonate.		●	
		Y3	<i>EN_</i> Polycarbonate protection with LED lighting.	<i>IT_</i> Protezione in polycarbonato con illuminazione LED.	<i>ES_</i> Protección de policarbonato con iluminación LED.	<i>FR_</i> Protection en polycarbonate avec éclairage LED.	cm 100 h cm 55	●	
	Z3	<i>EN_</i> Polycarbonate protection with heating lamp. Only to be combined with appliance Art. HOT60. See page 162.	<i>IT_</i> Protezione in polycarbonato con lampada riscaldante. Abbinabile solo all'applicazione Art. HOT60. Vedi pagina 162.	<i>ES_</i> Protección de policarbonato con lámpara de calentamiento. Para ser combinado solo con aplicación Art. HOT60. Ver página 162.	<i>FR_</i> Protection en polycarbonate avec lampe chauffante. Combinable seulement avec l'application Art. HOT60. Voir page 160.		●		

## Counter equipped with 18/10-AISI 304 refrigerated basin.

3 GN 1/1 - cm 106x62x(h)3 - 350W.



ART. NEW CUBE 120F/W5/C2/COL55/X3

*IT\_* Banco equipaggiato di vasca refrigerata in acciaio inossidabile 18/10-AISI 304.  
*ES\_* Mostrador equipado con cubeta refrigerada en acero inoxidable 18/10-AISI 304.  
*FR\_* Comptoir équipé d'un bac réfrigéré en acier inoxydable 18/10-AISI 304.

colours available	matt finish	W1	B1	C2
	climb finish	W5	B2	C1
	ultra matt finish	W2	B6	C7
	wood finish	R1	Q1	A1
	mirror finish	E1	U1	

### Optional

#### Neutral polycarbonate protection.

*IT\_* Protezione neutra in policarbonato.

*ES\_* Protección de policarbonato.

*FR\_* Protection neutre en polycarbonate.

## Some examples

## Some examples

## Counter equipped with refrigerated glass-ceramic top. 2 GN 1/1 - cm 53x66 - 170W - 50/60Hz.



ART. NEW CUBE 120F/W5/S1/COL54/X3

*IT\_* Banco equipaggiato di piano refrigerato in vitroceramica.  
*ES\_* Mostrador equipado con tapa refrigerada de vitrocerámica.  
*FR\_* Comptoir équipé de plateau en vitrocéramique réfrigéré.

colours available	matt finish	W1	B1	C2
	climb finish	W5	B2	C1
	ultra matt finish	W2	B6	C7
	wood finish	R1	Q1	A1
	mirror finish	E1	U1	

### Optional

#### Neutral polycarbonate protection.

*IT\_* Protezione neutra in policarbonato.

*ES\_* Protección de policarbonato.

*FR\_* Protection neutre en polycarbonate.





**Counter equipped with 18/10 stainless steel-  
AISI 304 heating plate. 4 GN 1/1 - cm 103x64 -  
+30°/+ 90°C - 1200W - 230V- 50/60Hz.**



ART. NEW CUBE 120F/W5/B6/HOT60/Z3

- IT\_* Banco equipaggiato di piano caldo in acciaio inossidabile 18/10-AISI 304 e protezione in policarbonato con lampada riscaldante.  
*ES\_* Mostrador equipado con placa calentadora de acero inoxidable 18/10-AISI 304 y protección en policarbonato con lámpara de calentamiento.  
*FR\_* Comptoir équipé de unité de chauffage en acier inoxydable 18/10-AISI 304 et protection en polycarbonate avec lampe chauffante.

colours available	
matt finish	W1 B1 C2
climb finish	W5 B2 C1
ultra matt finish	W2 B6 C7
wood finish	R1 Q1 A1
	E1 U1
mirror finish	G1 S1

**Optional**

**Polycarbonate protection with heating lamp.**

*IT\_* Protezione in policarbonato con lampada riscaldante.

*ES\_* Protección de policarbonato con lámpara de calentamiento.

*FR\_* Protection en polycarbonate avec lampe chauffante.

## Counter equipped with induction glass-ceramic tabletop heat-retaining unit.



ART. NEW CUBE 120F/W1/C2/IND51/X3

*IT\_* Banco equipaggiato di unità di mantenimento del calore a induzione in vetroceramica.  
*ES\_* Mostrador equipado con unidad de retención de calor a Inducion de vidrio cerámica.  
*FR\_* Comptoir équipé d'unité de rétention de chaleur à induction en vitrocéramique.

colours available	matt finish	W1	B1	C2
	climb finish	W5	B2	C1
	ultra matt finish	W2	B6	C7
	wood finish	R1	Q1	A1
		E1	U1	
	mirror finish	G1	S1	

Optional

**Neutral polycarbonate protection.**

*IT\_* Protezione neutra in polycarbonato.

*ES\_* Protección de polycarbonato.

*FR\_* Protection neutre en polycarbonato.

## Some examples

## Some examples

## Counter equipped with tempered glass heating plate. Two individually adjustable thermostats. cm 106x53x(h)7 - 600W - 230V - 50/60Hz.



ART. NEW CUBE 120F/W5/C1/HOT59/X3

*IT\_* Banco equipaggiato di piano caldo in vetro temperato con due termostati indipendenti.  
*ES\_* Mostrador equipado con placa calentadora de vidrio templado con dos termostatos ajustables individualmente.  
*FR\_* Comptoir équipé de plateau chauffante en verre trempé avec deux thermostats à réglage individuel.

colours available	matt finish	W1	B1	C2
	climb finish	W5	B2	C1
	ultra matt finish	W2	B6	C7
	wood finish	R1	Q1	A1
		E1	U1	
	mirror finish	G1	S1	

Optional

**Neutral polycarbonate protection.**

*IT\_* Protezione neutra in polycarbonato.

*ES\_* Protección de polycarbonato.

*FR\_* Protection neutre en polycarbonato.



# naked



Naked is a collection of kitchens with simple but elegant shapes. An extremely functional product designed to meet the needs of professionals in the culinary world, it can be equipped with latest-generation appliances that make it perfect for gastronomic events.

*IT\_* Naked è una collezione di cucine dalle linee semplici ma eleganti. Un prodotto estremamente funzionale e studiato per soddisfare le esigenze dei professionisti del mondo culinario, può essere attrezzata con applicazioni di ultima generazione che la rendono perfetta per eventi gastronomici.

*ES\_* Naked es una colección de cocinas con líneas simples pero elegantes. Un producto extremadamente funcional diseñado para satisfacer las necesidades de los profesionales del mundo culinario, puede equiparse con aplicaciones de última generación que lo hacen perfecto para eventos gastronómicos.

*FR\_* Naked est une collection de cuisines aux lignes simples mais élégantes. Produit extrêmement fonctionnel, conçu pour répondre aux besoins des professionnels du monde culinaire, il peut être équipé d'applications de dernière génération qui le rendent parfait pour les événements gastronomiques.





ART. LED1

**Multi-coloured LED strip equipped with remote control for surprising lighting effects during evening service.**

- IT\_* Striscia LED multicolore dotata di telecomando remoto per effetti luce sorprendenti durante il servizio serale.
- ES\_* Tira LED multicolor equipada con control remoto para efectos de iluminación sorprendentes durante el servicio nocturno.
- FR\_* Bande LED multicolore équipée d'une télécommande pour des effets de lumière surprenants pendant le service de nuit.

**5 colours in one led strip.**

- IT\_* 5 colori in un'unica striscia LED.
- ES\_* 5 colores en una sola tira de LED.
- FR\_* 5 couleurs dans une seule bande de LED.

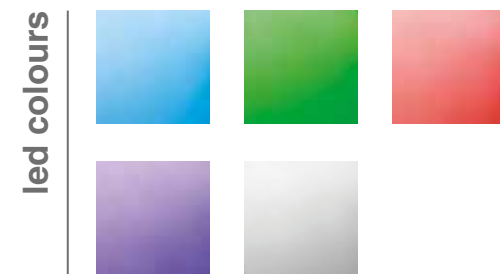

**Some examples**

**Kitchen equipped with pasta cooker, induction glass-ceramic hob and sink.**



ART. NAKED 10/R1/PRO10/PRO15

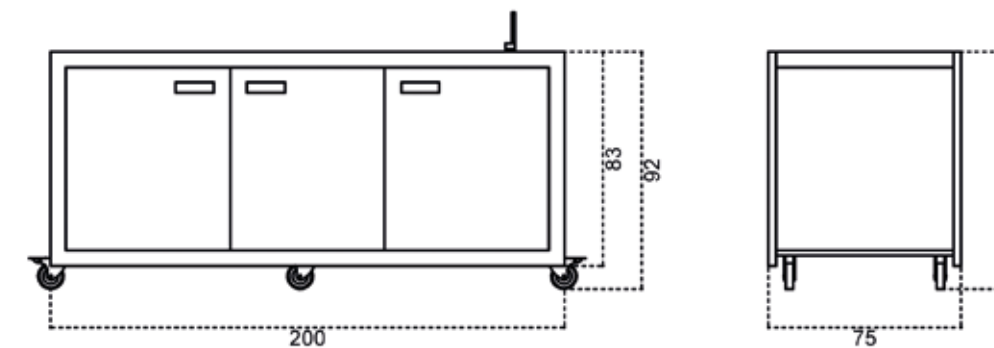

BASIC MODEL: ART. NAKED 10 Appliances: see pages 116-119.

*EN\_* Live cooking station with three doors and sink.

*IT\_* Live cooking station con tre ante e lavamani con rubinetto.

*ES\_* Live cooking station con tres puertas y fregadero.

*FR\_* Live cooking station avec trois portes et évier.

- IT\_* Cucina equipaggiata di cuocipasta, piano cottura a induzione in vitroceramica e lavamani.
- ES\_* Cocina equipada con cocedero de pasta, fregadero de inducción en vitrocerámica y fregadero.
- FR\_* Cuisine équipée de cuiseur à pâtes, plaque à induction en vitrocéramique et évier.



colours available	
matt finish	W1 B1
climb finish	W5 B2
wood finish	R1 Q1 A1
	E1 U1



## Trolley with two removable drawers equipped with soft closing and handle.



ART. NAKED 1/R1

*IT\_* Carrello con due cassetti rimovibili dotati di chiusura ammortizzata e maniglia.  
*ES\_* Carrito con dos cajones extraíbles equipados con cierre suave y manija.  
*FR\_* Chariot avec deux tiroirs extractibles équipés de fermeture en douceur et poignée.

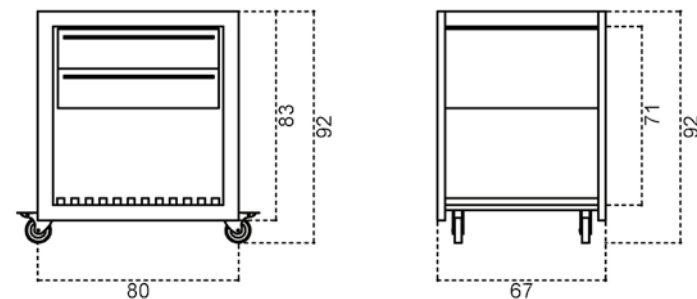

colours available	matt finish	W1	B1
	climb finish	W5	B2
	wood finish	R1	Q1
		E1	U1

## Some examples

### Kitchen equipped with glass-ceramic hot maintenance plate and induction hob.



ART. NAKED 6/R1/PRO7/PRO15

*IT\_* Cucina equipaggiata di piano di mantenimento del caldo e piano cottura a induzione in vetroceramica.  
*ES\_* Cocina equipada por plan de conservación del calor y placa de inducción de vidrioocerámica.  
*FR\_* Cuisine équipée de plan de conservation de la chaleur et plaque à induction en vitrocéramique.

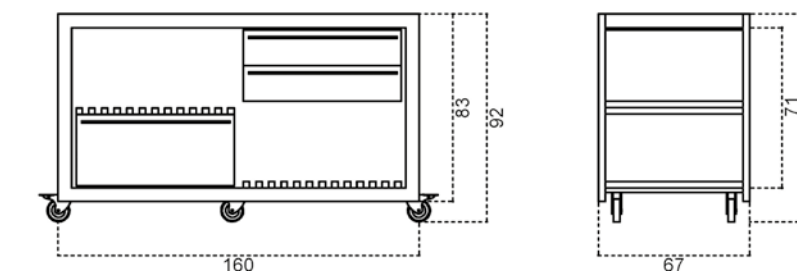

colours available	matt finish	W1	B1
	climb finish	W5	B2
	wood finish	R1	Q1
		E1	U1

**BASIC MODEL: ART. NAKED 6** Appliances: see pages 116-119.

*EN\_* Live cooking station with three drawers.

*IT\_* Live cooking station con tre cassetti.

*ES\_* Live cooking station con tres cajones.

*FR\_* Live cooking station avec trois tiroirs.

## Kitchen equipped with sink and GN 1/1 basin, depth mm. 60. Built-in refrigerator included. Refrigerator, lt 60 +10,2 - A+ - 230 Vac.



ART. NAKED OYSTER 7/W1

*IT\_* Cucina equipaggiata di lavandino e vasca GN 1/1, prof. mm 60. Frigorifero ad incasso incluso.  
*ES\_* Cocina equipada por fregadero y tanque GN 1/1, prof. mm 60. Refrigerador incorporado incluido.  
*FR\_* Cuisine équipée d'évier et baignoire GN 1/1, prof. mm 60. Réfrigérateur intégré inclus.

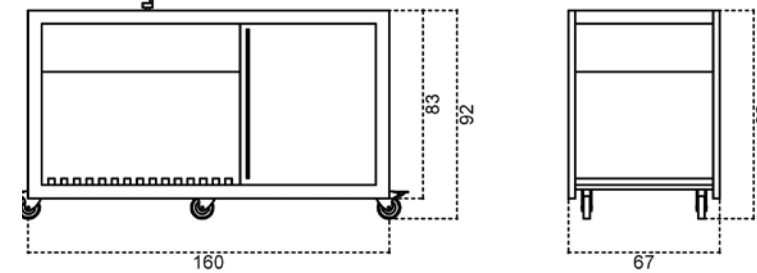

colours available	matt finish	W1	B1
	climb finish	W5	B2
	wood finish	R1	Q1
		E1	U1

## Cocktail station equipped with professional instrumentation. Built-in refrigerator included. Refrigerator, lt 60 +10,2 - A+ - 230 Vac.



ART. NAKED HAPPY HOUR 8/B1

*IT\_* Una cocktail station fornita di strumentazione professionale. Frigorifero incluso.  
*ES\_* Una estacion cocktail equipada con herramientas profesionales. Refrigerador incorporado.  
*FR\_* Une station de cocktails équipée d'instruments professionnels. Réfrigérateur intégré.

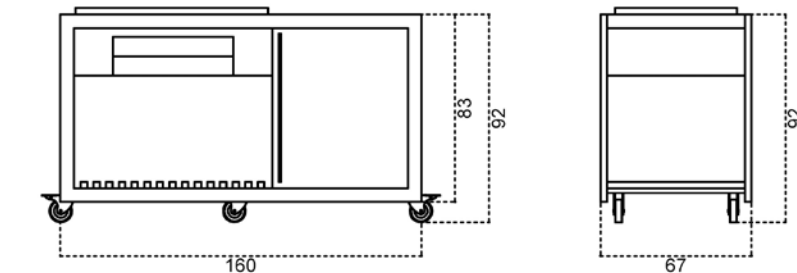

colours available	matt finish	W1	B1
	climb finish	W5	B2
	wood finish	R1	Q1
		E1	U1





## Some examples

### Kitchen equipped with two lava stone grill plates.



ART. NAKED 25/B1/DOM5/DOM5

*IT\_* Cucina equipaggiata di due piastre grill a pietra lavica.  
*ES\_* Cocina equipada por dos placas grill de piedra de lava.  
*FR\_* Cuisine équipée avec deux plaques grill en pierre de lave.

*EN\_* Wooden cut board, cm 74x25.  
*IT\_* Tagliere in legno.  
*ES\_* Tabla de cortar de madera.  
*FR\_* Planche à découper en bois.

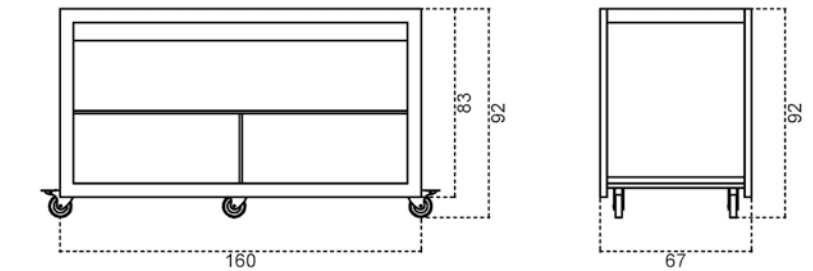

colours available	matt finish	W1	B1	C2
	climb finish	W5	B2	C1
	ultra matt finish	W2	B6	C7
	wood finish	R1	Q1	A1
		E1	U1	

**BASIC MODEL: ART. NAKED 25** Appliances: see pages 116-119.

*EN\_* Live cooking station with three glove compartments.

*IT\_* Live cooking station con tre vani portaoggetti.

*ES\_* Live cooking station con tres guanteras.

*FR\_* Live cooking station avec trois compartiments de stockage.





## Kitchen equipped with two lava stone grill plate and tempered glass protection.



ART. NAKED 26/B1/DOM5/DOM5/P25

- IT\_* Cucina equipaggiata di due piastre grill a pietra lavica e protezione in vetro temperato.  
*ES\_* Cocina equipada por dos placas grill de piedra de lava y protección en vidrio templado.  
*FR\_* Cuisine équipée de deux plaques grill en pierre de lave et protection en verre trempé.

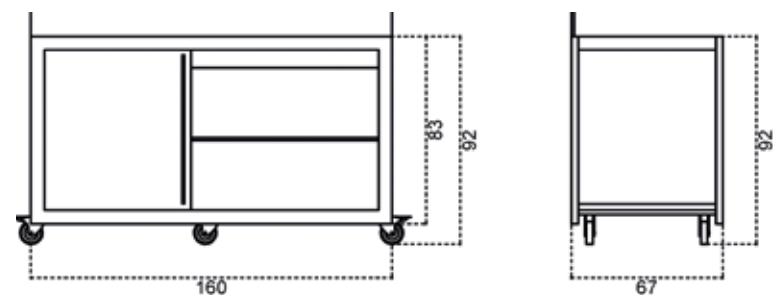

colours available	matt finish	W1	B1	C2
	climb finish	W5	B2	C1
	ultra matt finish	W2	B6	C7
	wood finish	R1	Q1	A1
		E1	U1	

BASIC MODEL: ART. NAKED 26 **Appliances: see pages 116-119.**

*EN\_* Live cooking station with one door and two glove compartments.

*IT\_* Live cooking station con un'anta e due vani portaoggetti.

*ES\_* Live cooking station con una puerta y dos compartimentos de almacenamiento.

*FR\_* Live cooking station avec une porte et deux compartiments de stockage.

## Some examples

## Some examples

## Kitchen equipped with two induction glass-ceramic hobs and tempered glass protection.



ART. NAKED 250/E1/DOM25/DOM25

- IT\_* Cucina equipaggiata di due piani cottura ad induzione in vitroceramica e una protezione in vetro temperato.  
*ES\_* Cocina equipada por dos placas de inducción en vitrocerámica y protección de vidrio templado.  
*FR\_* Cuisine équipée de deux plaques à induction en vitrocéramique et protection en verre trempé.

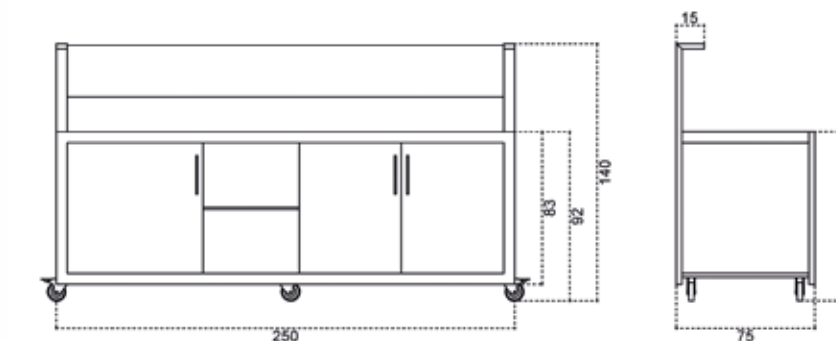

colours available	matt finish	W1	B1	C2
	climb finish	W5	B2	C1
	ultra matt finish	W2	B6	C7
	wood finish	R1	Q1	A1
		E1	U1	

BASIC MODEL: ART. NAKED 250 **Appliances: see pages 116-119.**

*EN\_* Live cooking station with three doors and tempered glass protection.

*IT\_* Live cooking station con tre ante e protezione in vetro temperato.

*ES\_* Live cooking station con tres puertas y protección de vidrio templado.

*FR\_* Live cooking station avec trois portes et une protection en verre trempé.





**EN\_ Accommodates up to 5 GN 1/1 appliances.**

*IT\_ Ospita fino a 5 applicazioni GN 1/1.*

*ES\_ Admite hasta 5 aplicaciones GN 1/1.*

*FR\_ Accepte jusqu'à 5 applications GN 1/1.*



**EN\_ Anchor hook. Ø cm 9 - h cm 4,5.**

*IT\_ Gancio di ancoraggio.*

*ES\_ Gancho anclado.*

*FR\_ Crochet d'ancorage.*

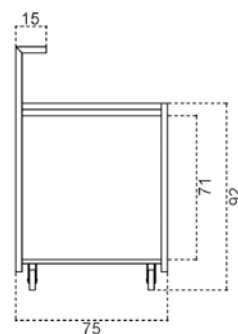
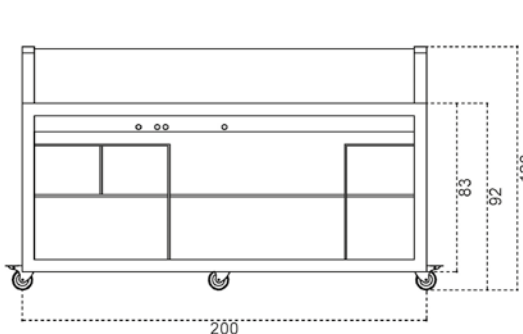
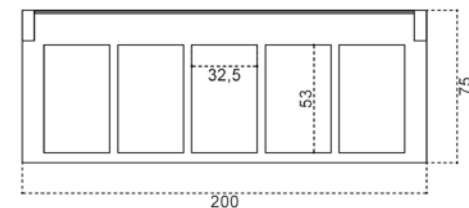

## Some examples

### Kitchen equipped with pasta cooker, infrared glass-ceramic hob, induction wok hob and tempered glass protection.



ART. NAKED 200/B1/PRO10/PRO1/PRO16

*IT\_ Cucina equipaggiata di cuoci pasta, piano cottura a infrarossi in vitroceramica, piano cottura a induzione wok e protezione in vetro temperato.*

*ES\_ Cocina equipada con cocedero de pasta, placa de vidriocerámica infrarrojo, encimera wok de inducción y protección en vidrio templado.*

*FR\_ Cuisine équipé de cuiseur à pâtes, plaque en vitrocéramique à infrarouge, table de cuisson wok à induction et protection en verre trempé.*



colours available	
matt finish	W1 B1 C2
climb finish	W5 B2 C1
ultra matt finish	W2 B6 C7
wood finish	R1 Q1 A1
	E1 U1

**BASIC MODEL: ART. NAKED 200** Appliances: see pages 116-119.

**EN\_ Live cooking station with 6 drawers provided with GN 1/1 plastic tray, depth mm 65 and protection in tempered glass with table top, cm 200x28.**

*IT\_ Live cooking station con sei cassetti provvisti di vassoi GN 1/1, prof. mm 65 e protezione in vetro temperato con piano d'appoggio per piatti, cm 200x28.*

*ES\_ Live cooking station con seis cajones provistos en bandeja de plástico GN 1/1, prof. mm 65 y protección en vidrio templado con llano de apoyo para platos, cm 200x28.*

*FR\_ Live cooking station avec six tiroirs fournis de bac GN 1/1 en plastique, prof. mm 65 et protection en verre trempé avec surface pour assiettes, cm 200x28.*



**EN\_ Accommodates up to 5 GN 1/1 appliances.**

*IT\_ Ospita fino a 5 applicazioni GN 1/1.*

*ES\_ Admite hasta 5 aplicaciones GN 1/1.*

*FR\_ Accepte jusqu'à 5 applications GN 1/1.*

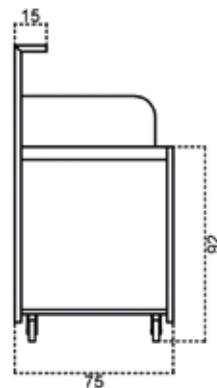
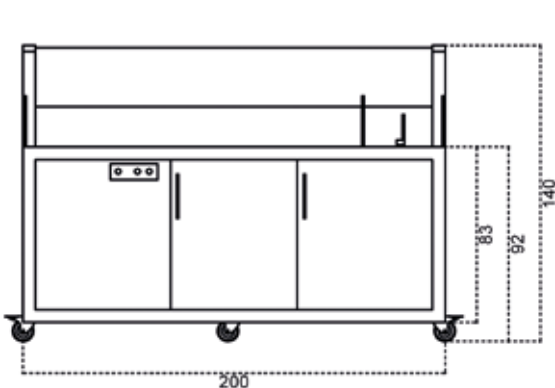
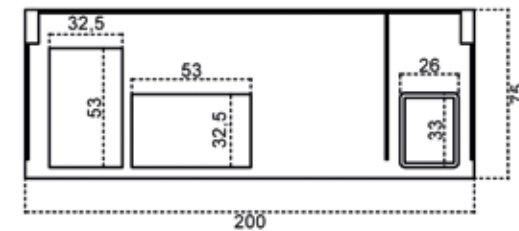

## Some examples

**Kitchen equipped with pasta cooker, TeppanYaki plate, handwash tank\* with glass partition, cm 35-h cm 24 and protection in tempered glass with a table top for plates, cm 200x28. Complete with tempered glass side protection, cm 60-h cm 24.**



ART. NAKED 150/B1/PRO10/PRO6

*IT\_ Cucina equipaggiata da cuocipasta, piastra TeppanYaki, lavamani\* con separatore in vetro, cm 35-h cm 24 e protezione in vetro temperato con piano d'appoggio per piatti, cm 200x28. Completo di protezione laterale in vetro temperato, cm 60-h cm 24.*

*ES\_ Cocina equipada por cocedero de pasta, placa TeppanYaki, lavadero\* con separador de vidrio, cm 35-h cm 24 y protección en vidrio templado con llano de apoyo para platos, cm 200x28. Completo con protección lateral de vidrio templado, cm 60-h cm 24.*

*FR\_ Cuisine équipée de cuiseur à pâtes, plaque TeppanYaki, lave-mains\* avec séparateur de verre, cm 35-h cm 24 et protection en verre trempé avec plateau pour assiettes, cm 200x28. Complet avec protection latérale en verre trempé, cm 60-h cm 24.*

\*

**EN\_ On request, available with connection to the external water supply.**

*IT\_ Su richiesta, disponibile con collegamento alla rete idrica esterna.*

*ES\_ A pedido, disponible con conexión al suministro externo de agua.*

*FR\_ Sur demande, disponible avec raccordement à l'alimentation en eau externe.*

colours available	matt finish	W1	B1	C2
	climb finish	W5	B2	C1
	ultra matt finish	W2	B6	C7
	wood finish	R1	Q1	A1
		E1	U1	

**BASIC MODEL: ART. NAKED 150**

**Appliances: see pages 116-119.**

**EN\_ Live cooking station with three doors, tempered glass protection and side protection. Complete with handwash tank.**

*IT\_ Live cooking station con tre ante, protezione e protezione laterale in vetro temperato. Completa di lavamani.*

*ES\_ Live cooking station con tres puertas, protección y protección lateral en vidrio templado. Completa con lavadero.*

*FR\_ Live cooking station avec trois portes, protection et protection laterale en verre trempé. Complete avec lave-mains.*



**EN\_ Accommodates up to 4 GN 1/1 appliances.**

*IT\_ Ospita fino a 4 applicazioni GN 1/1.*

*ES\_ Admite hasta 4 aplicaciones GN 1/1.*

*FR\_ Accepte jusqu'à 4 applications GN 1/1.*

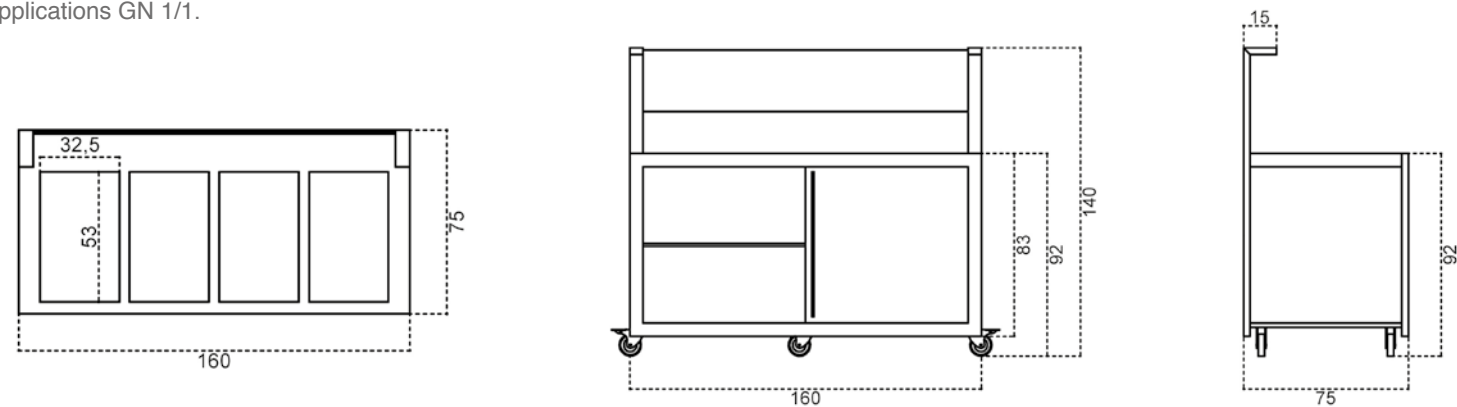

## Some examples

### Kitchen equipped with protection in tempered glass with table top, cm 160x28, glass-ceramic hot maintenance plate and TeppanYaki plate.



ART. NAKED 160/B1/PRO7/PRO6

colours available	matt finish		
	W1	B1	C2
	climb finish		
	W5	B2	C1
	ultra matt finish		
	W2	B6	C7
	wood finish		
	R1	Q1	A1
	E1	U1	

**BASIC MODEL: ART. NAKED 160** Appliances: see pages 116-119.

*EN\_ Live cooking station with one door and tempered glass protection.*

*IT\_ Live cooking station con un'anta e protezione in vetro temperato.*

*ES\_ Live cooking station con una puerta y protección de vidrio templado.*

*FR\_ Live cooking station avec une porte et protection en verre trempé.*

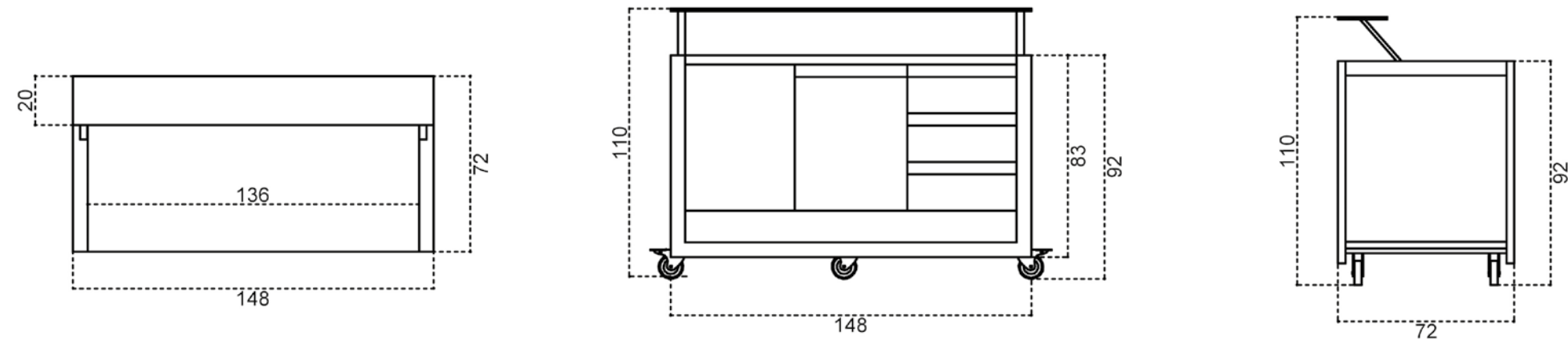

## Kitchen equipped with refrigerated drawers and professional refrigerator with forced ventilation system.



*IT\_* Cucina equipaggiata da cassetti refrigerati e frigorifero professionale con sistema di ventilazione forzata.  
*ES\_* Cocina equipada por cajones refrigerados y refrigerador profesional con sistema de ventilación forzada.  
*FR\_* Cuisine équipée de tiroirs réfrigérés et réfrigérateur professionnel avec système de ventilation forcée.

### Details



**EN\_ Two removable refrigerated drawers for easy cleaning. Equipped with soft closing.**

*IT\_* Due cassetti refrigerati ed estraibili per facilitare la pulizia. Equipaggiati di chiusura ammortizzata.

*ES\_* Dos cajones refrigerados y extraíbles para facilitar la limpieza. Equipados con cierre suave.

*FR\_* Deux tiroir réfrigérés et amovibles pour un nettoyage facile. Équipé avec fermeture en douceur.



**EN\_ Built-in refrigerator. Adjustable temperature from -2 to +8°C. 230V - 50Hz.**

*IT\_* Frigorifero ad incasso.

*ES\_* Nevera empotrada.

*FR\_* Réfrigérateur intégré.



### Optional ①

**Service shelf. cm 148x20.**

*IT\_* Piano di servizio.

*ES\_* Llano de servicio.

*FR\_* Plan de service.



ART. NAKED 27/B1

colours available	finish	W1	B1	C2
	matt finish	W1	B1	C2
	climb finish	W5	B2	C1
	ultra matt finish	W2	B6	C7
	wood finish	R1	Q1	A1
		E1	U1	



# cast iron cocottes



## Cast iron cocottes.



IT\_ Cocottes in ghisa.  
ES\_ Cocottes en hlerro fundido.  
FR\_ Cocottes en fonte.



■ ART. COC10RED  
COCOTTE Ø cm 10, lt 0,25.

■ ART. COC10BLACK  
COCOTTE Ø cm 10, lt 0,25.



■ ART. COC20RED  
COCOTTE Ø cm 20, lt 2,5.

■ ART. COC20BLACK  
COCOTTE Ø cm 20, lt 2,5.



■ ART. COC24RED  
COCOTTE Ø cm 24, lt 4.

■ ART. COC24BLACK  
COCOTTE Ø cm 24, lt 4.



■ ART. COC28RED  
COCOTTE Ø cm 28, lt 3,4.

■ ART. COC28BLACK  
COCOTTE Ø cm 28, lt 3,4.



■ ART. COC30RED  
COCOTTE Ø cm 23x30, lt 5.

■ ART. COC30BLACK  
COCOTTE Ø cm 23x30, lt 5.



ART. TEL53  
TRAY Ø cm 53x32,5x(h)6,5.

ART. TEL32  
TRAY Ø cm 32,5x26,5x(h)6,5.



cm 25x25

ART. SOTT25/W5

ART. SOTT25/B2

cm 25x45

ART. SOTT45/W5

ART. SOTT45/B2

### Under pot.

IT\_ Sottopentola.

ES\_ Bajo holla.

FR\_ Sous pot.

cm 33x33x(h)11- 2100W - 230V

ART. 100789000000

### Glass-ceramic electric plate. Round infrared plate Ø cm 21, with regulator and residual heat lamp.



IT\_ Piastra elettrica in vetro ceramica. Piastra ad infrarossi tonda Ø cm 21, con regolatore e lampada per il calore residuo.

ES\_ Placa eléctrica con vidrio cerámico. Placa infrarroja redonda Ø cm 21, con regulador y lámpara de calor residual.

FR\_ Plaque électrique en verre céramique. Plaque infrarouge ronde Ø cm 21, avec régulateur et lampe à chaleur résiduelle.

### Custom made protective cloth in polyester and PVC, reinforced with inner corners for outdoor storage.

IT\_ Telo di protezione in poliestere e PVC con angoli interni rinforzati, realizzato su misura per esterni.

ES\_ Tela protectora en poliéster y PVC reforzada con esquinas interiores hecha a medida, para el almacenamiento al aire libre.

FR\_ Protection sur mesure en polyester et PVC avec angles internes renforcé pour le stockage en plein air.



ART. TE80





# LIFESTYLE MOVING EXPERIENCE

**EN\_** The diversified range of products Deagostini Inox aims to respect some essential manufacturing principles. Their indispensable functionality is harmoniously combined with a cutting-edge design, which never neglects the latest generation technology. This is how our products come to life beautiful, practical, durable and guaranteed “Made in Italy”.

**IT\_** La gamma diversificata dei prodotti Deagostini Inox si propone di rispettare alcuni principi fondamentali di manifattura. La loro imprescindibile funzionalità si accosta armoniosamente ad un design d'avanguardia, che mai trascurava la tecnologia di ultima generazione. Nascono così i nostri prodotti, belli da vivere, pratici, duraturi e garantiti “Made in Italy”.

**ES\_** La gama diversificada de los productos Deagostini Inox es creado para respetar algunos principios esenciales de manufactura. La loro imprescindible funcionalidad se acerca armoniosamente a un design de vanguardia, que nunca deja a medias la tecnología de última generación. Nacen así nuestros productos, bellos en vivirlos, prácticos, y garantizado “Made in Italy”.

**FR\_** La gamme diversifiée de produits Deagostini Inox vise à respecter certains principes de fabrication fondamentaux. Leur essentielle fonctionnalité est harmonieusement combinée avec un design de pointe, qui ne néglige jamais les technologies de dernière génération. C'est ainsi que nos produits prennent vie, beaux, pratiques, durables et garantis “Made in Italy”.





# SKILLS. DESIGN. PASSION.

**EN\_** Six collections of buffet systems, tradition of Deagostini Inox manufacturing, revisited and revolutionized to transform each device into a functional and design tool. The wide range available offers not only the essential tools of a buffet service, but also lots of solutions for hot and cold maintenance, with the chance of creating endless combinations of customization.

**Our sales department will be happy to assist you in creating a customized project!**

**IT\_** Sei collezioni di linee buffet, tradizione della manifattura Deagostini Inox, rivisitate e rivoluzionate per trasformare ogni dispositivo in uno strumento funzionale e di design. La vasta gamma a disposizione offre, non solo gli essenziali strumenti del servizio buffet, ma anche numerose soluzioni per il mantenimento del caldo e del freddo, con la possibilità di creare infinite combinazioni di personalizzazione.

Il nostro ufficio vendite sarà lieto di assistervi nella creazione di un progetto su misura!



Ask for our "Lifestyle" catalogue.

## +LUX

**EN\_** Innovative materials combined with mirror finish stainless steel for a unique design, strong aesthetic appeal and sophisticated style.

**IT\_** Materiali innovativi accompagnati dall'acciaio inossidabile lucidato a specchio per un design unico, forte appeal estetico e stile raffinato.



## TRUE STEEL

**EN\_** Reliability, durability and tradition. A modular and functional design with strict rules of attention to materials.

**IT\_** Affidabilità, durevolezza e tradizione. Un design componibile e funzionale con rigorose regole di attenzione ai materiali.



## BLACK

**EN\_** Black wood, colour of elegance and refinement. Lava stone, a unique material in modern culinary innovation.

**IT\_** Il legno nero, colore di eleganza e raffinatezza. La pietra lavica, un materiale unico nell'innovazione culinaria moderna.



## SHINY STEEL

**EN\_** Stainless steel embellished by the shine of the mirror finish for a rigorous, clean and light collection. A modern design that does not forget the needs of professional comfort.

**IT\_** L'acciaio inossidabile impreziosito dalla finitura a specchio per una collezione rigorosa, pulita e leggera. Un design moderno che non prescinde dalle esigenze di comfort professionale.



## MY WOOD

**EN\_** A reinterpretation of wood in a contemporary and functional way, warm and passionate.

**IT\_** Una rivisitazione del legno in veste contemporanea e funzionale, calda e appassionata.



## GLASSY

**EN\_** The glass give life to a fully customizable collection that can satisfy the needs of space and exposure.

**IT\_** Il vetro dà vita ad una collezione interamente personalizzabile che può soddisfare tutte le esigenze di spazio ed esposizione.





# MODULARITY. ADAPTABILITY. FUNCTIONALITY.

**EN\_** All Deagostini Inox trolleys collections are represented by modular products, easy to transport and maintain, made with progressive, resistant, durable and strong materials. The wide range of colour finishes allow an easily set of our product in any environment. While the several optionals available allow the transformation of a trolley into a real mobile kitchen.

**IT\_** Tutte le collezioni dei carrelli Deagostini Inox sono rappresentate da prodotti interamente modulari, di facile trasporto e manutenzione, con materiali innovativi, resistenti e duraturi. Le numerose finiture di colore tra cui scegliere permettono di inserire facilmente il nostro prodotto ad ogni ambiente. I numerosi optionals a disposizione consentono infine la trasformazione di un carrello in una vera e propria cucina mobile.



Ask for our "Moving" catalogue.

## LUX

**EN\_** Collection of independent and autonomous modular system that combine the latest generation appliances and functionality with their elegant and essential style.

**IT\_** Una collezione di sistemi modulari ed autonomi che combinano al loro stile elegante ed essenziale applicazioni di ultima generazione, nonché funzionalità.



## WOOD

**EN\_** A reinterpretation of wood in a contemporary and functional way, warm and passionate. A fine manufacture that makes both trolleys and dining room furniture an ideal furnishing complement as they are made with passion and competence.

**IT\_** Una rivisitazione del legno in veste contemporanea e funzionale, calda e appassionata. Una fine manifattura che rende sia i carrelli che i mobili da sala un complemento d'arredo ideale.



## CROSS FRAME OPEN

**EN\_** Modern, elegant and functional trolleys collection. Their simplicity makes them the ideal product to adapt to any environment and satisfy any need.

**IT\_** Collezione di carrelli moderna, elegante e funzionale. La loro semplicità li rende il prodotto ideale per adattarsi ad ogni ambiente e soddisfare qualsiasi necessità.



## PASTRY

**EN\_** A collection entirely dedicated to the world of pastry and desserts.

**IT\_** Una collezione interamente dedicata al mondo della pasticceria e dei dolci.



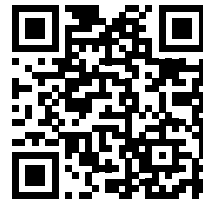

Ask for our Lifestyle catalogue or find it here.



Many thanks to:

Villa Nigra, Miasino - Parco le Cicogne, Barengo - Hotel Cortese, Armeno - Hotel San Rocco, Orta San Giulio - Calathea, Pettenasco.

**EN\_ Deagostini Inox S.r.l. reserves the right to make any changes to its products deemed useful for the qualitative improvement of the same, both dimensional and structural. Sales conditions are available upon request. All parts and materials with food contact have been tested and approved for food contact.**

All rights reserved - © Deagostini Inox S.r.l.

**IT\_ Deagostini Inox S.r.l. si riserva il diritto di apportare ai propri prodotti qualsiasi modifica ritenuta utile al miglioramento qualitativo degli stessi, sia dimensionale che strutturale. Le nostre condizioni commerciali sono disponibili su richiesta. Tutti i componenti ed i materiali a contatto con gli alimenti sono stati testati e approvati come idonei ad uso alimentare.**

Tutti i diritti riservati - © Deagostini Inox S.r.l.







**DEAGOSTINI INOX S.R.L.**

Via Comoli, 93/A

28887 Omegna (VB) - ITALY

Phone +39 0323 862804 / +39 0323 862991

Fax +39 0323 861591

e-mail: [info@deagostini-inox.it](mailto:info@deagostini-inox.it)

[www.deagostini-inox.it](http://www.deagostini-inox.it)