



**ADVENTYS**

**INNOVATIVE INDUCTION EQUIPMENT**



**Made In France**

## MEET THE TEAM



**Florian Cikalleshi**

France Sales Manager

[florian.cikalleshi@adventys.com](mailto:florian.cikalleshi@adventys.com) / +33 659 054 583



**Mathilde Perot Bell**

Export Sales Director

[mathilde.perot@adventys.com](mailto:mathilde.perot@adventys.com) / +33 770 329 675



**Henry Tan**

Export Sales Manager - Asian market

[henry@adventys.com](mailto:henry@adventys.com) / +60 196 648 839



**Antje Krieger**

Export Sales Manager - European market

[antje.krieger@adventys.com](mailto:antje.krieger@adventys.com) / +33 682 100 305



**Vanessa Andreetto**

Sales Administration Manager - France

[vanessa.andreetto@adventys.com](mailto:vanessa.andreetto@adventys.com) / +33 380 204 615



**Clara Pellegrini**

Communication & Marketing Manager

[marketing@adventys.com](mailto:marketing@adventys.com) / +33 380 204 615

# TABLIÉ DES MATIÈRES

**2** THE COMPANY  
Learn more about Adventys

**4** L'OCTOPUS  
The 2021 innovation

**6** BUFFET RANGE

- Induc Stone p.8
- Induc Elegance p.10
- Drop-in Buffet p.14
- Counter-top Buffet p.15

**16** COOKING RANGE **Geoline**

- Snacking p.18
- Counter-top p.20
- Drop-in p.22

**24** COOKING RANGE **Bioline**

- Counter-top p.27
- Drop-in p.30

**34** HEAVY DUTY RANGE

- Traditional Induction p.36
- Plancha p.37
- No-Limit p.38
- Wok p.40
- Cupboard / Stockpot p.40-41

**42** KIT RANGE

- Traditional Induction p.44
- No-Limit p.46
- Plancha p.47



## Induction

Induction is our **core business**. For over 20 years, we have been designing and manufacturing this technology for the Adventys brand and for many of our partners.

Induction is the **fastest, most precise, most sanitary, most innovative and most versatile** technology.

Whether it is vacuum cooking, warming, cooking at low temperature (such as melting chocolate at 31°C) or at very high temperature (boil 6L of water in 6min): **everything is possible with Adventys technology.**

## International

Present in **more than 75 countries**, Adventys is now represented on all the 5 continents.

Our first export zone is **Asia, closely followed by the United States**, but we are also all over **Europe, Australia, New-Zealand, Russia, United Arab Emirates, Qatar, in Brazil and Canada!**

Our ability to export is possible thanks to our **innovative patents, competitive prices and products in stock year round.**

## Innovation

Innovation is in our DNA and is **our strength**.

In fact, each year Adventys invests **10% of its turnover** in its Research & Development department.

We set ourselves apart from the multinationals in our sector by offering **innovative products and patents**, and by **continuously improving** our existing product lines.

Adventys patents have won **several international innovation awards** at trade shows in our industry.

## Intégration

What is **vertical integration** of the manufacturing process at Adventys?

This is 1 factory in which we **manufacture our products in their entirety:**

Electronic boards, sheet metal, gluing, coils production and assembly as well as numerous quality controls throughout the manufacturing process.

And of course, we stock our entire catalogue on the shelf to deliver our partners **within deadlines defying any competition.**





*The french expertise*

Founded more than **20 years ago**, the company **Adventys**, based in Seurre in Burgundy, is the leading **French designer and manufacturer** of kitchen equipment with induction technology.

Induction technology combines many advantages: **Precision - Safety - Ecology - Efficiency - Speed.**

The manufacturing process is fully integrated, our production workshops allow us to **manufacture** our electronic boards, to **wind** our coils, to **make** the connections, to **shape** the stainless steel and, of course, to **assemble and test** our cooking appliance on our site in Burgundy.

In 2019, significant investments enabled Adventys to expand its finished product storage area in order to ensure the best delivery times for its customers.

We are one of the few companies in Europe to have our **own single-phase and three-phase voltage induction technology**. We offer it in different ranges and different configurations covering the majority of catering and community needs.

*Did you know ?*



*Adventys is a family business, Jean-Luc Pérot, the CEO, was joined by his daughter Mathilde in 2008. She is now in charge for export sales. In March 2020, Jeanne, his second daughter, joined him and is in charge of industrial activity.*

**1999**

Manufacturer of induction cooking equipment for HoReCa professionals for **over 20 years**



3000m<sup>2</sup> of buildings and offices



We export our products to more than **80 countries** worldwide



An SME of **40 people**



**5.2 million euros** turnover

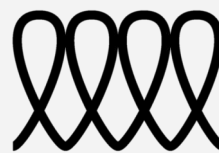

R&D

Countless innovations & patents over **30 years** of induction experience

# OCTOPUS Kitchen-in-a-box

**L'Octopus** sports a two zones induction cooker, removable griddle & plancha plates. Use the removable side shelves for prep work or gastro dishes. L'Octopus is an outdoor & indoor cooking equipment, a real culinary swiss knife.

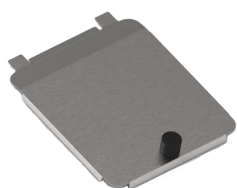
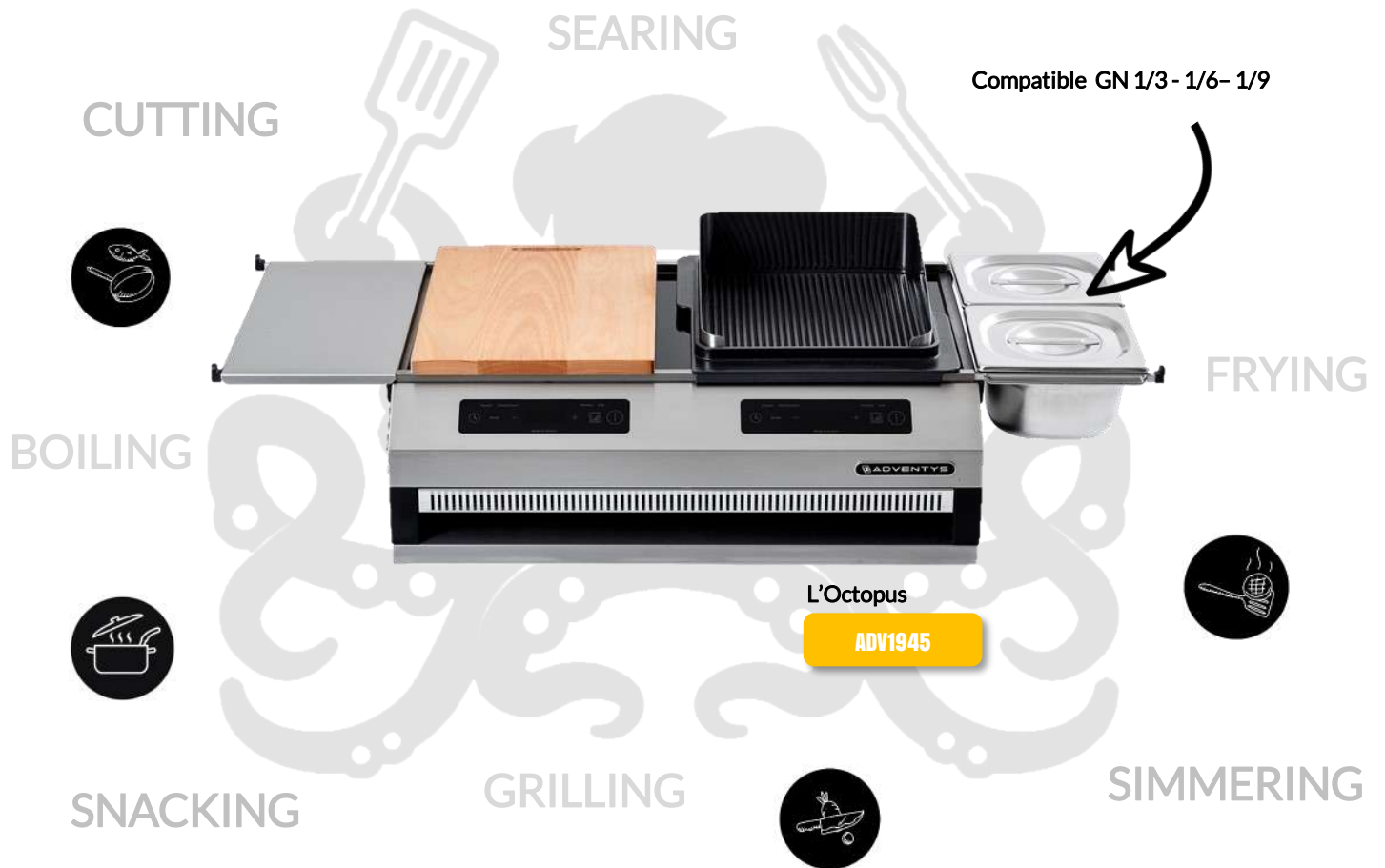

Cooking lid

ADV1920



Cast iron Grill

ADV1920



Cast iron Plancha

ADV1919



Grease guard

ADV1949



Cutting board

ADV1918

## Octopus Pack

- > 2 induction zones
- > 2 retractable backings for shelf or gastronorm containers
- > Cast iron Plancha & Grill accessories
- > Removable filter
- > Storage under product
- > **Compatible** trolley
- > Compatible GN 1/3 - 1/6 - 1/9 (included frame)

## Product features

- > Power: **3500W** (2x1750W)
- > Vitroceramic dimensions 280 x 560 mm
- > Integrated capacitive touches control panel, watt power setting and temperature setting to the nearest degree.
- > **Boost (to power up to 3500W on 1 zone and Timer 180 minutes)**
- > **Special heating program** for cast iron plancha & grill
- > Power supply 220-240V single-phase - 50-60Hz
- > Design and made in France



Trolley S/S - Black

Chariot S/S

ADV1906

ADV1906

**Buffet Line**



*The Adventys buffet range offers equipment for keeping warm by induction. With powers between 300 and 1000W, Adventys buffet are available in both counter-top and drop-in versions. Thanks to their innovative and elegant design, the appliances of the range embellish and adorn the buffets of the most beautiful places around the world as The Saffron Restaurant in the Atlantis The Palm hotel in Dubai or also the Razorback Stadium in Arkansas (+ than 400 products).*

# Induc-Stone

#InvisibleInduction

An innovative and unique invisible buffet solution. This induction kit fits your granite, quartz, ceramic concrete, wood worktop and more. Without the need for cutting, once installed, the kit becomes invisible and makes your worktop versatile. For optimum safety, the surface does not exceed 55 °C but the interior temperature of the chafing-dish can be controlled and reach maximum 90 °C.

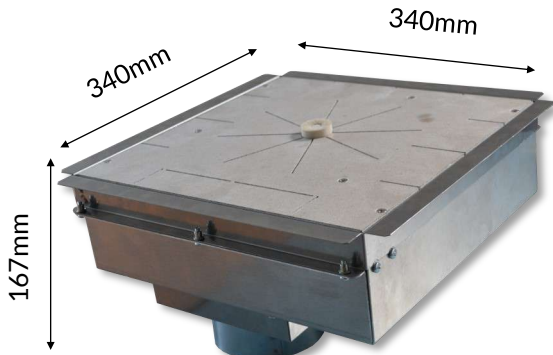

## INDUC-STONE

- > Power 650 watts
- > Product dimensions 340 x 340 x 167mm
- > Deported control panel with 4 touches and 2 digits, setting and display of temperature (20 levels of temperature) and 99 minutes timer.
- > Power supply: 220-240V single phased / 50-60Hz
- > Including 1m80 power cable
- > Designed and made in France
- > Including a spacer - Compulsory use
- > *Control panel cut-out dimensions: 48x163mm*

**ADV1587**



*New control panel 3 touches/4 digits*

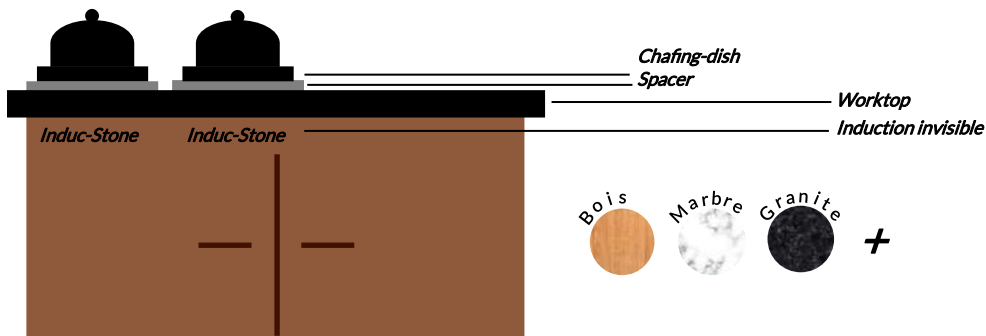

## New

> Control up to 5 units with a single control panel (upon request).

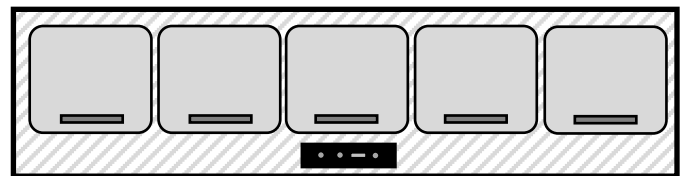



ATLANTIS

DUBAI

*The Saffron Restaurant – Atlantis The Palm Dubai*

*Made by TSSC*

# Induc-Elegance

#BuffetInduction

*Induc-Elegance Buffets stand out for their aesthetics and fully customizable design. You can choose from 4 standard models or create a unique combination thanks to a large palette of colours and materials. Light, compact and stackable, its use is simple and the handling is quick. They are transportable thanks to their dedicated tailor-made suitcase.*

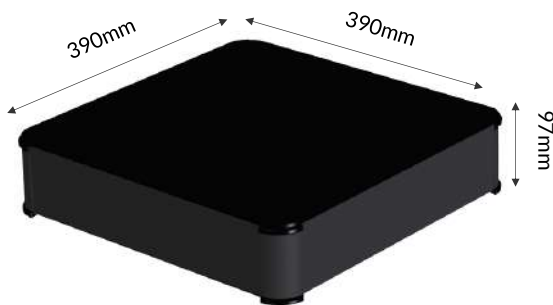

## INDUC-ELEGANCE

- > Power: 300 or 1000 watts
- > Glass dimensions 390 x 390 x thk 4 mm
- > Product dimensions 390 x 390 x 97 mm
- > Capacitive touches control panel and 12 levels of temperature setting.
- > Power supply 220-240V single phased / 50-60Hz
- > Option: Interconnection cable which permits to connect 4 products together for 300W and up to 2 for 1000W version
- > 4 standard models, customizable version upon request
- > Designed and made in France

## Models

Black - Stainless-Steel



300 Watts

ADV1809

1000 Watts

ADV1850

S/S - S/S



300 Watts

ADV1810

1000 Watts

ADV1851

Copper - Black



300 Watts

ADV1831

1000 Watts

ADV1852

Black-Black



300 Watts

ADV1832

1000 Watts

ADV1853

# Induc-Elegance **Drop-in or Flushed**

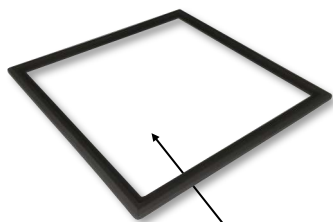
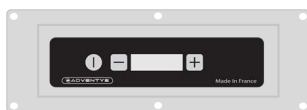
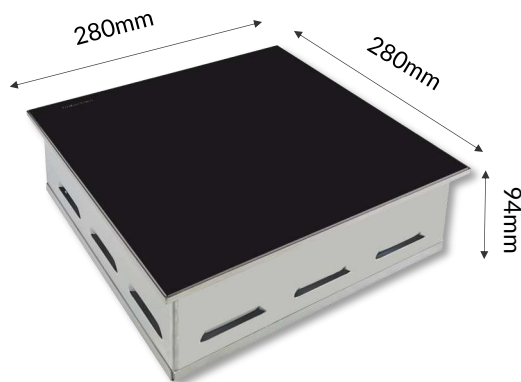

Silicone seal

## INDUC -ELEGANCE F DIR

- > Power 300 or 1000 watts
- > Glass dimensions 280 x 280 x thk 4 mm
- > Product dimensions 280 x 280 x 94 mm
- > Remote control panel with 3 capacitive touches and 12 power setting
- > Power supply 220 - 240V single-phase / 50-60Hz
- > Supplied with silicone seal for drop-in
- > Options: Interconnection cable to connect up to 4 products together (300W version) and up to 2 products for 1000W version.
- > Designed and made in France

> *Product cut-out dimensions: 270 x 270 mm*

> *Control panel cut-out dimensions 198 x 68 mm*

**300 Watts**

**ADV1816**

**1000 Watts**

**ADV1835**



# Induc-Elegance **Large format**

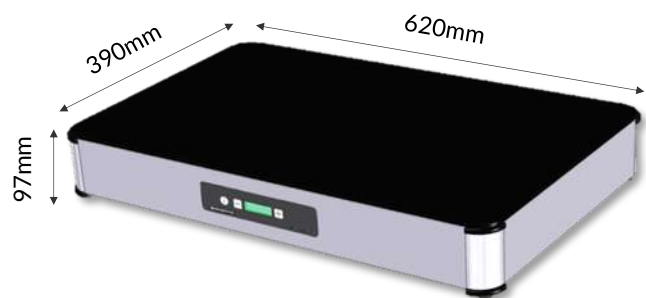

## INDUC- ELEGANCE IE+300 - 1 ZONE

- > Power 300 watts
- > Glass dimensions 620 x 390 x thk 4 mm
- > Product dimensions 620 x 390 x 97mm
- > Capacitive touches control panel and 12 levels of temperature setting
- > Power supply 220-240V single-phase / 50-60Hz
- > Option: Interconnection cable to connect up to 4 products together
- > 4 standard models, customizable version upon request
- > Designed and made in France

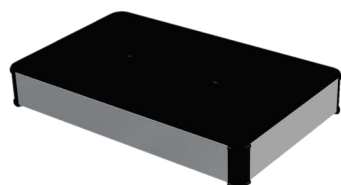

Black - Stainless-Steel

ADV1837

S/S - S/S

ADV1838

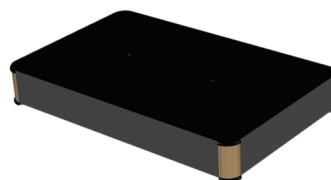
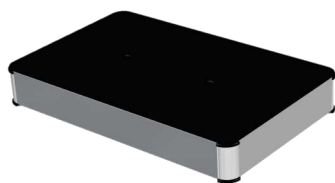

Black-Black

ADV1840

Copper - Black

ADV1839

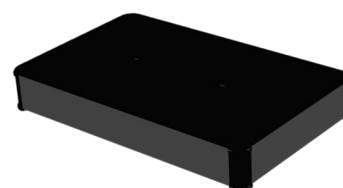

# Induc-Elegance **Large format**

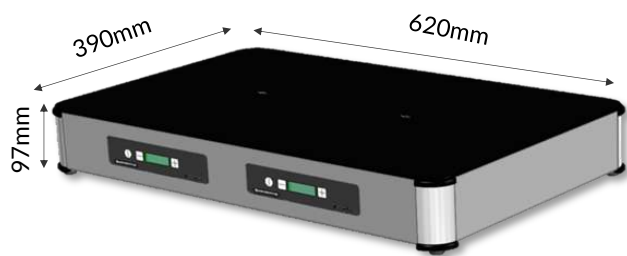

## INDUC -ELEGANCE IE2 600 - 2 ZONES

- > Power 2 x 300 watts
- > Glass dimensions 620 x 390 x thk 4 mm
- > Product dimensions 620 x 390 x 97mm
- > 2 capacitive touches control panel and 12 levels of temperature setting
- > Power supply 220-240V single-phase / 50-60Hz
- > No interconnection with this version
- > 4 standards models, customizable version upon request
- > Designed and made in France



Black - Stainless-Steel

ADV1841

S/S - S/S

ADV1842



Black - Black

ADV1844



Copper - Black

ADV1843



# Buffet Drop-in

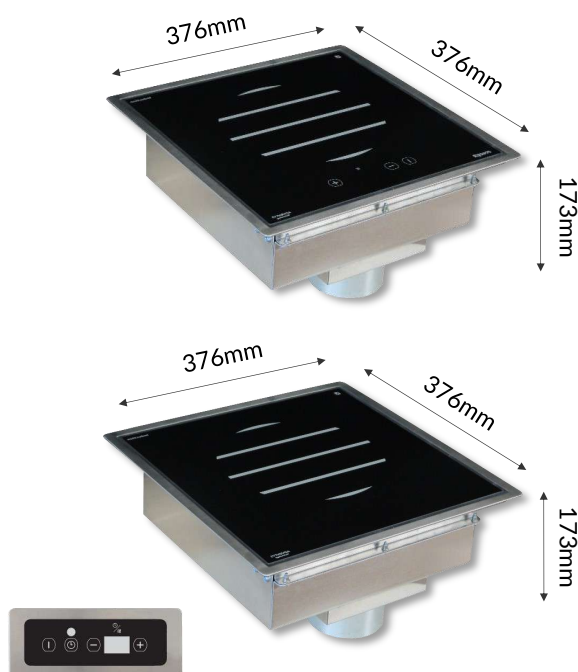

## GL 650 DI / DIR

- > Power 650 watts
- > Glass dimensions 376 x 376 mm
- > Product dimensions 376 x 376 x 173mm
- > Capacitive touches control panel (integrated or remote) - On/Off, timer manual temperature setting (+/-) with 2 digits display (works for both timer and power).
- > Power supply 220-240V single-phase / 50-60Hz
- > Including 1m80 power cable
- > Designed and made in France
- > *Product cut-out dimensions: 352 x 352 mm*
- > *Control panel cut-out dimensions: 48 x 163 mm*

**DI 650 Watts**

**ADV1637**

**DIR 650 Watts**

**ADV1638**

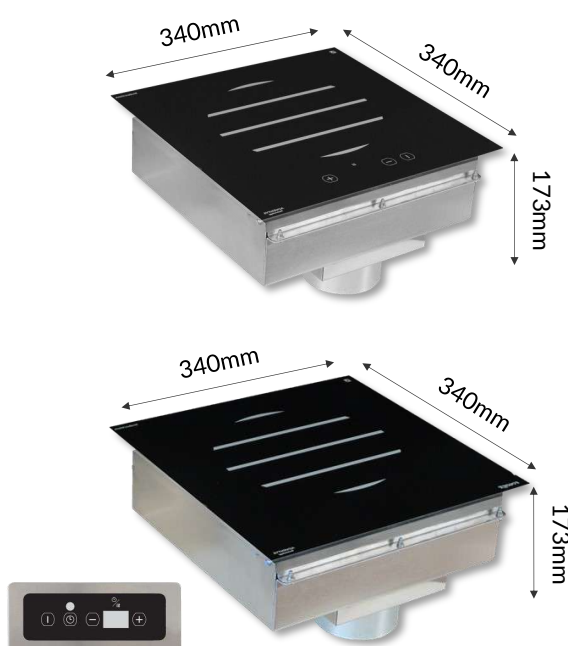

## GL 650 FL/FLR

- > Power 650 watts
- > Glass dimensions 340 x 340 mm
- > Product dimensions 340 x 340 x 173 mm
- > Capacitive touches control panel (remote or integrated) - On/Off, timer, manual temperature setting (+/-) with 2 digits display for both timer and power.
- > Power supply 220-240V single-phase / 50-60Hz
- > Designed and made in France
- > *Product cut-out dimensions: 48 x 163 mm*
- > *Control panel cut-out dimensions: 346 x 346 mm*

**FL 650 Watts**

**ADV1494**

**FLR 650 Watts**

**ADV1552**



# Buffet counter-top



### ARIC 2200

- > Power 2200 watts
- > Glass dimensions 280 x 280 mm
- > Product dimensions 280 x 280 x 94 mm
- > Capacitive touches control panel - On/Off, manual power setting (+/-) with a 1 digit display
- > Power supply 220-240V single-phase / 50-60Hz
- > Designed and made in France

### ARIC 2200

ADV1815



### NRIC 2800

- > Power 2800 watts
- > Glass dimensions 280 x 280 mm
- > Product dimensions 280 x 280 x 94 mm
- > Capacitive touches control panel - On/Off, manual power setting (+/-) and timer with 2 digits display each
- > 3 presets
- > Power supply 220-240V single-phase / 50-60Hz
- > Designed and made in France

### NRIC 2800

ADV1817

**snacking Line** **GEOLINE**

---

*The Geoline Adventys Cooking range offers induction cooking equipment. With higher powers, between 2500 and 3500W per zone in single-phase, the range is available in counter-tops, drop-in and flushed. You will surely find a product that matches your need with our traditional inductions, our planchas or even our induction woks. The many different features allow us to meet most of the expectations of the catering industry.*

# GEOLINE snacking

#IngeniousCooking



## GLN 2500 / 3000 / 3500 - 1 zone counter-top

- > Power 2500 / 3000 or 3500W
- > Glass dimensions 280 x 280 protected on 4 sides
- > Product dimensions 310 x 385 x 110mm
- > Capacitive touches control panel - manual power or temperature setting (+/-) with 2 digits display
- > Power supply 220-240V single phase / 50-60Hz
- > Timer control with 2 digits display
- > MAX key to reach maximal power instantly
- > Designed and made in France

2500 Watts

ADV1870

3000 Watts

ADV1869

3500 Watts

ADV1702

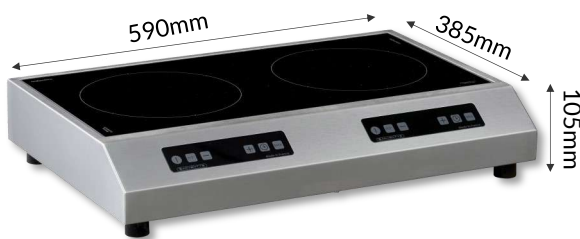

## GLN2 3000 / 3500 S - 2 zones counter top - side by side

- > Power 2 x 1500 or 2 x 1750 watts
- > Product dimensions 590 x 385 x 105mm
- > Glass dimensions 280 x 560 protected on 4 sides
- > Capacitive touches control panel, manual power (watts) or temperature (°C) setting in 5°C step.
- > Power supply 220-240V single phase / 50-60Hz
- > Timer control with 2 digits display
- > MAX key to reach maximal power instantly
- > Designed and made in France

3000 Watts

ADV1698

3500 Watts

ADV1797



## GLN2 3000 / 3500 F - 2 zones counter top - front to back

- > Power 2 x 1750 watts
- > Product dimensions 310 x 665 x 105mm
- > Glass dimensions 280 x 560 protected on 4 sides
- > Capacitive touches control panel, manual power (watts) or temperature (°C) setting in 5°C step.
- > Power supply 220-240V single-phase / 50-60Hz
- > Designed and made in France

3000 Watts

ADV1699

3500 Watts

ADV1779



# GEOLINE counter-top



## GL2 6000 S: Large 2 zones - side by side

- > Power 5000 / 6000 / 7000 watts
- > Glass dimensions 650 x 323 mm
- > Product dimensions 650 x 405 x 96 mm
- > Capacitive touches control panel (x2) - On/Off, timer control, manual power setting (+/-) with 2 digits display for both time and power.
- > Power supply 220-240V single-phase - 50-60Hz - power cord without plug for single-phase or three-phase connection.
- > Designed and made in France

5000 Watts

ADV1619

6000 Watts

ADV1551

7000 Watts

ADV1754



## GL2 6000 F: Large 2 zones - front to back

- > Power 2 x 2500 / 2 x 3000 / 2 x 3500 watts
- > Glass dimensions 650 x 370mm
- > Product dimensions 730 x 370 x 140mm
- > Capacitive touches control panel (x2) - On/Off, timer control, manual power setting (+/-) with 2 digits display for both time and power.
- > Power supply 220-240V single-phase - 50-60Hz - power cord without plug for single-phase or three-phase connection.
- > Designed and made in France

5000 Watts

ADV1620

6000 Watts

ADV1594

7000 Watts

ADV1755

# GEOLINE counter-top



## GLP 6000 : Induction plancha 2 zones 6000 watts

- > Power 6000 watts
- > Cooking surface 688 x 384 mm
- > Product dimensions 695 x 470 x 275 mm
- > Capacitive touches control panel x2 - On/Off, manual temperature setting (+/-) with 4 digits display. Temperature going from 30°C to 250°C
- > Power supply 220-240V single-phase (works from 185 à 270 and from 35 à 70 Hz) power cord without plug for single-phase or three-phase connection.
- > Equipped with grease drawer and grease guard
- > Designed and made in France

6000 Watts

ADV1557



## GLW 3000 / 3500 Induction wok

- > Power 3000 or 3500 watts
- > Coil and glass designed in wok format
- > Product dimensions 390 x 430 x 161 mm
- > Capacitive touches control panel, On/Off manual power setting (+/-) and timer control with 2 digits display for both timer and power.
- > Power supply 220-240V single-phase 50 à 60 Hz) power cord with plug for single-phase connection.
- > Including a wok pan
- > Designed and made in France

3000 Watts

ADV1676

3500 Watts

ADV1610

# GEOLINE Drop-in

#IngeniousCooking



## GL 3000 DI / DIR - 1 zone induction

- > Power 3000 watts
- > Glass dimensions 340 x 340 mm
- > Product dimensions 376 x 376 x 173 mm
- > Capacitive touches control panel (remote or integrated). On/Off, timer power setting (+/-) with 2 digits display for both timer and power.
- > Power supply 220-240V single-phase - 50-60Hz
- > Designed and made in France

> *Product cut-out dimensions 352 x 352 mm*

> *Control panel cut-out dimensions 48 x 163 mm*

### GL 3000 DI

Integrated control panel

ADV1546

### GL 3000 DIR

Remote control panel

ADV1628

## GL2 DIR from 3000 to 7000 W - 2 zones induction

- > Power 2 x 1500 / 2 x 1750 / 2 x 2500 / 2 x 3000 / 2 x 3500 watts
- > Glass dimensions 663 x 314 mm
- > Product dimensions 700 x 350 x 182mm
- > Capacitive touches control panel (push button). On/Off, timer control, power setting (+/-) with 2 digits display.
- > Power supply 220-240V single-phase - 50-60Hz
- > Designed and made in France

> *Product cut-out dimensions 333 x 682 mm*

> *Control panel cut-out dimensions 60 x 302 mm*

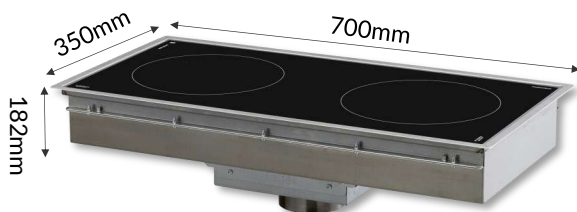

3000 Watts

ADV1621

3500 Watts

ADV1645

5000 Watts

ADV1622

6000 Watts

ADV1623

7000 Watts

ADV1756



# GEOLINE Flushed

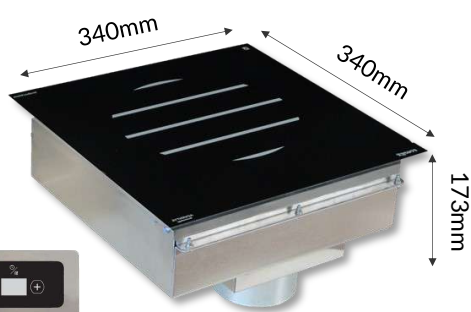
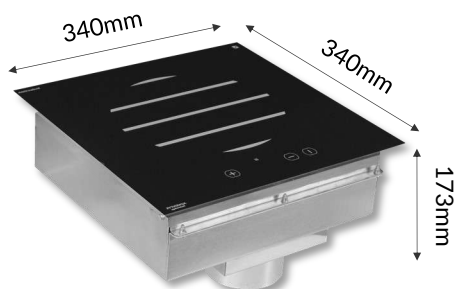

## GL 3000 FL / FLR

- > Power 3000 watts
- > Glass dimensions 340 x 340 mm
- > Product dimensions 340 x 340 x 173 mm
- > Capacitive touches control panel. On/Off, timer, power setting (+/-) with 2 digits display for both timer and power.
- > Power supply 220-240V single-phase - 50-60Hz
- > Designed and made in France
- > *Product cut-out dimensions 346 x 346 mm*
- > *Control panel cut-out dimensions 43x163 mm*

### GL 3000 FL

Integrated control panel

ADV1549

### GL 3000 FLR

Remote control panel

ADV1548

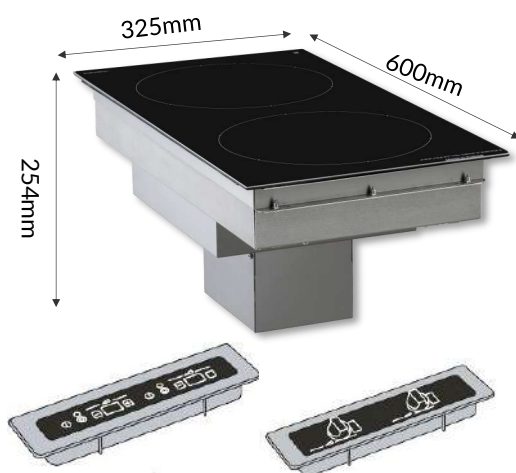

## GL2 FLR 3000-6000-7000 W - 2 zones induction

- > Power 2 x 1500 / 2 x 3000 / 2 x 3500 watts
- > Glass dimensions 600 x 325 mm
- > Product dimensions 600 x 325 x 254mm
- > Capacitive touches OR knob control panel. On/Off, timer, power setting (+/-) with 2 digits display for both timer and power
- > Power supply 220-240V single-phase - 50-60Hz
- > Designed and made in France
- > *Product cut-out dimensions 333 x 682 mm*
- > *Control panel cut-out dimensions 60 x 302 mm*

	3000 Watts	6000 Watts	7000 Watts
Knob	ADV1862	ADV1559	ADV1846
Capacitives	ADV1861	ADV1558	ADV1845

**cooking Line** BIOLINE

---

*The Bioline Adventys Cooking range offers induction cooking equipment with high powers between 3000 and 3600W in single-phase and up to 7000W in three-phase. The products of the Bioline range are robust and efficient devices, they are designed for 24 hours/7 use. Available in counter-top and drop-in format, you will also find planchas, wok and traditional induction.*



KOVSETS  
Technology

Timer

+

Minutes

Made in France

Temperature

+

°

P1

P2

-

315  
Power

# Bioline counter-top

#IngeniousCooking

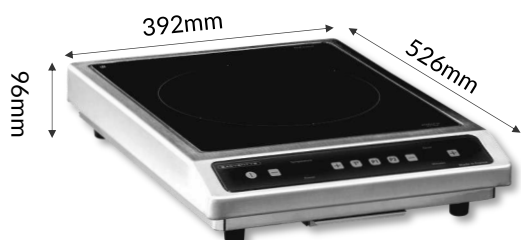

## BRIC - 1 zone induction - 3000 / 3600W

- > Power 3000 or 3600 watts
- > Glass dimensions 405 x 342 x thk 4mm
- > Product dimensions 526 x 392 x 96 mm
- > Capacitive touches control panel - On/Off, power level or watt level. Temperature setting in °C or °F (+/-) with 4 digits display for both power and temperature.
- > 2 presets + timer control with 2 digits display
- > Quality pan control + keyboard lock
- > Instant container temperature control
- > Power supply 220-240V single-phase - 50-60Hz
- > Designed and made in France

3000 Watts

ADV1476

3600 Watts

ADV1475

## Three-phase



## BTIC - 1 zones induction - 6000W three-phase

- > Power 6000 watts
- > Glass dimension 405 x 342 x thk 6mm
- > Product dimensions 392 x 526 x 185mm
- > Capacitive touches control panel. On/Off, manual power setting (+/-) and timer control with 2 digits display for both power and timer.
- > 3 programmable settings
- > Power supply 360-440V three-phase - 50-60Hz
- > Designed and made in France

6000 Watts

ADV1129

# Bioline couter-top



## B2RIC - 2 zones induction - 3000 / 3600W

- > Power 3000 or 3600 watts
- > Glass dimensions 405 x 342 x thk 4mm
- > Product dimensions 526 x 392 x 110 mm
- > Capacitive touches control panel. On/Off, manual power setting (+/-) with 2 digits display for each zone.
- > Power supply 220-240V single-phase - 50-60Hz
- > Designed and made in France

3000 Watts

ADV1740

3600 Watts

ADV1741



## BGIC - Induction Plancha 3000W/3600W

- > Power 3000 or 3600 watts
- > Cooking surface 300 x 371 mm
- > Product dimensions 526 x 392 x 196 mm
- > Capacitive touches control panel. Temperature setting from 30° to 250°C by 10°C step.
- > Grease drain - Option: grease guard
- > Power supply 220-240V single-phase - 50-60Hz
- > Designed and made in France

3000 Watts

ADV1878

3600 Watts

ADV1360



## BWIC 3000 / 3600 Induction Wok

- > Power 3000 or 3600 watts
- > Product dimensions 526 x 392 x 172 mm
- > Coil and glass designed in wok format
- > Capacitive touches control panel - On/Off, power level setting (+/-) and timer control with 2 digits display for both power and timer.
- > 3 programmable settings
- > Power supply 220-240V single-phase - 50-60Hz
- > Including wok pan
- > Designed and made in France

3000 Watts

ADV1607

3600 Watts

ADV1606

## Three-phase



## BTWIC 7000 Induction Wok three-phase

- > Power 7000 watts
- > Product dimensions 526 x 392 x 172 mm
- > Coil and glass designed in wok format
- > Capacitive touches control panel - On/Off, power level setting (+/-) and timer control with 2 digits display for both power and timer.
- > 3 programmable settings
- > Power supply 360-440V three-phase - 50-60Hz
- > Including wok pan
- > Designed and made in France

7000 Watts

ADV1483



## DRIC 3000 / 3600 - 1 zone induction

- > Power 3000 or 3600 watts
- > Glass dimensions 405 x 342 x thk 4mm
- > Product dimensions 580 x 440 x 170 mm
- > Capacitive touches control panel - On/Off, power level or watt level. Temperature setting in °C or °F (+/-) with 4 digits display for both power and temperature.
- > 2 programmable presets + timer control with 2 digits display
- > Quality pan control + keyboard lock
- > Instant container temperature control
- > Power supply 220-240V single-phase - 50-60Hz
- > Supplied with power cord without plug
- > Designed and made in France
- > *Product cut-out dimensions 410 x 550 mm*

3000 Watts

ADV1478

3600 Watts

ADV1471

## Three-phase



## DTIC 6000 - 1 zone induction **three-phase**

- > Power 6000 watts
- > Glass dimensions 405 x 342 x thk 4mm
- > Product dimensions 580 x 440 x 170 mm
- > Capacitive touches control panel. On/Off, manual power setting (+/-) and timer control with 2 digits display for both power and timer.
- > 2 programmable presets
- > Power supply 360-440 - three-phase - 50-60Hz
- > Supplied with power cord without plug
- > Designed and made in France
- > *Product cut-out dimensions 410 x 550 mm*

6000 Watts

ADV1369





# Bioline Drop-in



## D2RIC 3000 / 3600 - 2 zones induction

- > Power 2 x 1500 or 2 x 1800 watts
- > Glass dimensions 405 x 342 x thck 4mm
- > Product dimensions 580 x 440 x 185 mm
- > Capacitive touches control panel - On/Off, manual power setting (+/-) with 2 digits display for each zone.
- > Power supply 220-240V single-phase - 50-60Hz - power cord without plug
- > Designed and made in France

> *Product cut-out dimensions: 410 x 550 mm*

**3000 Watts**

ADV1742

**3600 Watts**

ADV1743

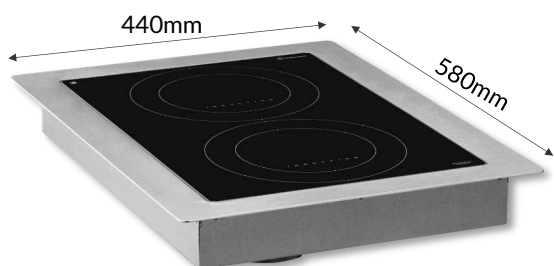

## D2IC / D2IM 6000 - 2 zones induction

- > Power 2 x 3000 watts
- > Glass dimensions 490 x 342 x thck 4 mm
- > Product dimensions 580 x 440 x 162 mm
- > Capacitive touches control panel - On/Off, manual power setting (+/-) with 2 digits display for each zone OR knobs control - Two 360° knobs with led light
- > Timer
- > Power supply 220-240V single-phase - 50-60Hz - power cord without plug
- > Designed and made in France

> *Product cut-out dimensions 410 x 550 mm*

> *Control panel cut-out dimensions 72 x 370 mm*



**Capacitive touches**

ADV1527

**Knobs**

ADV1537



### DWIC 3000 / 3600 Wok induction

- > Power 3000 or 3600 watts
- > Coil and glass designed in wok format
- > Product dimensions 580 x 440 x 300 mm
- > Capacitive touches control panel - On/Off, manual power setting (+/-) and timer control with 2 digits display for both power and timer.
- > 3 programmable settings
- > Power supply 220-240V single-phase - 50-60Hz -
- > Including wok pan and power cord without plug
- > Designed and made in France

> *Product dimensions cut-out: 410 x 550 mm*

**3000 Watts**

**ADV1609**

**3600 Watts**

**ADV1608**

### Three-phase



### DTWIC 7000 Wok induction **three-phase**

- > Power 7000 watts
- > Coil and glass designed in wok format
- > Product dimensions 580 x 440 x 300 mm
- > Capacitive touches control panel - On/Off, manual power setting (+/-) and timer control with 2 digits display for both power and timer.
- > 3 programmable settings
- > Power supply 360-440V three-phase - 50-60Hz
- > Including wok pan and power cord without plug
- > Designed and made in France

> *Product dimensions cut-out: 410 x 550 mm*

**7000 Watts**

**ADV1438**

### DGIC 3000 / 3600 Induction Plancha

- > Power 3000 or 3600W
- > Cooking surface 300 x 363 mm
- > Product dimensions 580 x 440 x 225 mm
- > Capacitive touches control panel - On/Off, manual temperature setting (+/-) with 4 digits display
- > 3 programmable settings
- > Power supply 220-240V single-phase - 50-60Hz
- > Grease drain - Option: grease guard
- > Designed and made in France

> *Product cut-out dimensions: 410 x 550 mm*

**3000 Watts**

**ADV1877**

**3600 Watts**

**ADV1349**



# **Heavy Duty Range**



*The Heavy Duty Adventys range offers induction solutions integrated into 400m or 800m furniture. Equipped with three-phase voltage, it is a powerful equipment which offers maximum performance. Available as a furniture module, it is also available as module that can be installed on existing worktop. You will find in this range our innovative NO-LIMIT technology.*

## Heavy-Duty

# Heavy-Duty Induction

### Three-phase



#### MO2i 8000 / 12000 - Modular - 2 zones induction three-phase

- > Power 2 x 4000 or 2 x 6000 watts
- > Glass dimensions 646 x 326 mm
- > Product dimensions 400 x 800 x 376-456 mm
- > 360° knob controls with 4 digits power display for each zone
- > Power supply 360-440V - three-phase - 50-60Hz
- > Designed and made in France
- > Adapted Adventys cupboard (p42-43)

8000 Watts

ADV1656

12000 Watts

ADV1657



#### MO4i 16.000 / 32.000 - Modular - 4 zones induction three-phase

- > Power 4 x 4000 or 4 x 6000 watts
- > Glass dimensions 2x (326x646mm)
- > Product dimensions 800 x 800 x 376-456 mm
- > 360° knob controls with 4 digits power display for each zone
- > Power supply 360-440V - three-phase - 50-60Hz
- > Designed and made in France
- > Adapted Adventys cupboard (p42-43)

16.000 Watts

ADV1658

24.000 Watts

ADV1659

# Heavy-Duty Plancha

## Three-phase



### MOP2i 8000 - Modular Plancha - 2 zones three-phase

- > Power 2 x 4000 watts
- > Cooking surface 330 x 600 mm
- > Product dimensions 400 x 800 x 376-456 mm
- > 360° knob controls with 4 digits temperature display
- > Power supply 360-440V - three-phase - 50-60Hz
- > Grease drain - Option: grease guard
- > Designed and made in France
- > Adapted Adventys cupboard (p42-43)

8000 Watts

ADV1660



### MOP4i 16.000 - Modular Plancha - 4 zones three-phase

- > Power 4 x 4000 watts
- > Cooking surface 750 x 630 mm
- > Product dimensions 900 x 900 x 456 mm
- > 360° knob controls with 4 digits temperature display
- > Power supply 360-440V - three-phase - 50-60Hz
- > Grease drain - Option: grease guard
- > Designed and made in France
- > Adapted Adventys cupboard (p42-43)

16.000 Watts

ADV1678

# Heavy-Duty MULTIZONE



## MO2NL 8000 / 16.000 Modular No-Limit 8 zones **three-phase**

- > Power 8 x 1000 or 8 x 2000 watts
- > Cooking surface 320 x 640 mm
- > Product dimensions 500 x 800 x 900-1029 mm
- > Capacitive touches control panel and incremental encoder. Each coil is set individually. Choice of power setting (watts) or exact temperature setting (°C).
- > 3 programmable settings
- > Power supply 360-440V - three-phase - 50-60Hz
- > Designed and made in France

8000 Watts

ADV1833

16.000 Watts

ADV1758

Awarded  
**SMART  
LABEL**



## MO4NL 16.000 / 32.000 Modular No-Limit 16 zones **three-phase**

- > Power 16 x 1000 or 16 x 2000 watts
- > Cooking surface 640 x 640 mm
- > Product dimensions 800 x 800 x 900-1029mm
- > Capacitive touches control panel and incremental encoder. Each coil is set individually. Choice of power setting (watts) or exact temperature setting (°C).
- > 3 programmable settings
- > Power supply 360-440V - three-phase - 50-60Hz
- > Designed and made in France

16.000 Watts

ADV1823

32.000 Watts

ADV1703



# Cooking Freedom

*Why use 4 pans when you can use 16?*

## **INDUC** **NO-LIMIT**



**Discover the concept in our video**

The No-Limit technology is an Adventys patented innovation. This unique concept offers a cooking surface from 4 to 16 coils of 1 or 2 kW each. Each inductor can be set individually but you can also choose a setting per zone (4 coils) with precision to the nearest degree.

You can place a large number of containers of any size over the entire surface and use multiple cooking methods: sear, boil, simmer...

Induc No-Limit lives up to its name, it opens up possibilities and allows you to maximise the space of your kitchen thanks to the wide choice of format and layout.



# Heavy-Duty wok



## MOWi Modular Wok Induction **three-phase**

- > Power 8000 watts
- > Glass and coil designed in wok format
- > Product dimensions 400 x 800 x 376-456 mm
- > 360° knob controls with 4 digits power display for each zone
- > Power supply 360-440V - three-phase - 50-60Hz - power cord with-out plug
- > Designed and made in France
- > Adapted Adventys cupboard (p42-43)

8000 Watts

ADV1661



## Cupboard 400

- > Full Inox
- > Specially designed for our heavy-duty range
- > Product dimensions 400 x 740 x 620-685 mm
- > Removable door
- > Pre-drilled for plancha grease drainage
- > Designed and made in France

400mm

ADV1685



### Cupboard 800

- > Full Inox
- > Specially designed for our heavy-duty range
- > Product dimensions 800 x 740 x 620-685 mm
- > Removable door
- > Pre-drilled for plancha grease drainage
- > Designed and made in France

800mm

ADV1686

Stockpot

# stockpot



### FISP Stockpot three-phase

- > Power 8000 watts
- > Glass dimensions 360 x 360 mm
- > Product dimensions 600 x 600 x 262-500 mm
- > Knob control + led
- > Made for cooking pots and large volume cooking
- > Power supply 360-440V three-phase - 50-60Hz
- > Maximum weight 100kg
- > Designed and made in France

8000 Watts

ADV1687

# **Kits Range**

---

---

*The Adventys Kits range brings together all our induction solutions for integration into existing furniture. You will find our traditional inductions, our planchas and woks as well as our No-Limit innovation available in several formats. Adventys supports you, now we can also design your custom-made projects and integrate the equipment ourselves.*

## Three-phase Kits

### Kit Traditional Induction

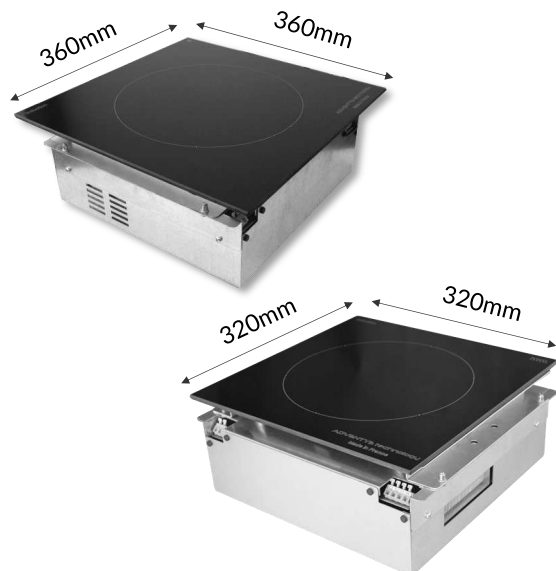

#### KTi1 4000 / 6000 Induction Kit - three-phase

- > Power 4000 or 6000 watts
- > Glass dimensions 320 x 320 mm or 360 x 360 mm
- > Knob remote control - (Capacitive touches upon request)
- > Power supply 360-440V three-phase - 50-60Hz
- > Upon request: Compatible with TERA WATT & SITRONIC energy optimizer
- > Designed and made in France
- > *Vitroc ceramic cut out dimensions 360: 366 x 366 mm*
- > *Vitroc ceramic cut out dimensions 320: 326 x 326 mm*

KTi1 4000	360x360mm	320x320mm	KTi1 6000	360x360	320x320
Integrated generator	<b>ADV1704</b>	<b>ADV1863</b>	Integrated generator	<b>ADV1706</b>	<b>ADV1811</b>
Remote generator	<b>ADV1705</b>	<b>ADV1888</b>	Remote generator	<b>ADV1707</b>	<b>ADV1887</b>

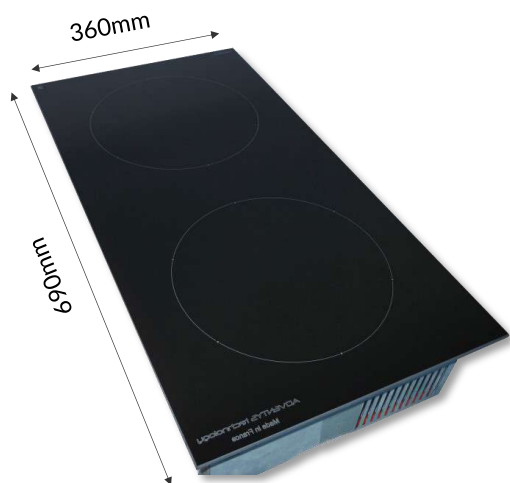

#### KTi2 8000/10.000 /12.000- 2 zones Induction Kit - three-phase

- > Power 8000 or 10.00 or 12.000 watts
- > Glass dimensions 360 x 690 mm or 325 x 600 mm
- > Knob remote control - (Capacitive touches upon request)
- > Power supply 360-440V three-phase - 50-60Hz
- > Upon request: Compatible with TERA WATT & SITRONIC energy optimizer
- > Designed and made in France
- > *Vitroc ceramic cut out dimensions 360: 366 x 696 mm*
- > *Vitroc ceramic cut out dimensions 325: 331 x 606 mm*

KTi2 8000	360x690	325x600	KTi2 10.000	360x690	325x600	KTi2 12.000	360x690	325x600
Integrated generator	<b>ADV1677</b>	<b>ADV1665</b>	Integrated generator	<b>ADV1689</b>	<b>ADV1885</b>	Integrated generator	<b>ADV1688</b>	<b>ADV1667</b>
Remote generator	<b>ADV1708</b>	<b>ADV1666</b>	Remote generator	<b>ADV1884</b>	<b>ADV1886</b>	Remote generator	<b>ADV1709</b>	<b>ADV1668</b>

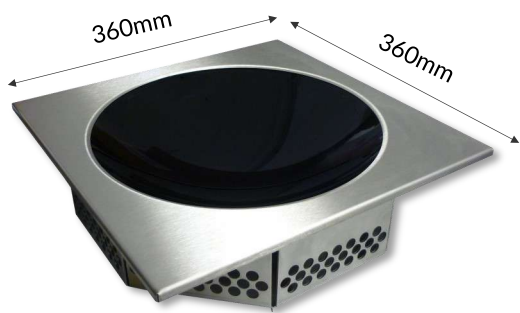

### KTWi1 4000 / 6000 Induction Kit - *three-phase*

- > Power 4000 or 6000 watts
- > Coil and glass designed in wok format
- > Product dimensions 320 x 320 mm or 360 x 360 mm
- > Knob remote control - (Capacitive touches upon request)
- > Power supply 360-440V three-phase - 50-60Hz
- > Upon request: Compatible with TERAWATT & SITRONIC energy optimizer
- > Designed and made in France
- > *Cut out dimensions : 366 x 366 mm*

<b>KTWI 4000 D</b>	360x360mm	<b>KTWI 6000 D</b>	360x360
Remote generator	<b>ADV1710</b>	Remote generator	<b>ADV1711</b>



*Credit photo Société Mainini*

## Three-phase Kits

# Kits NO-LIMIT - MULTIZONE

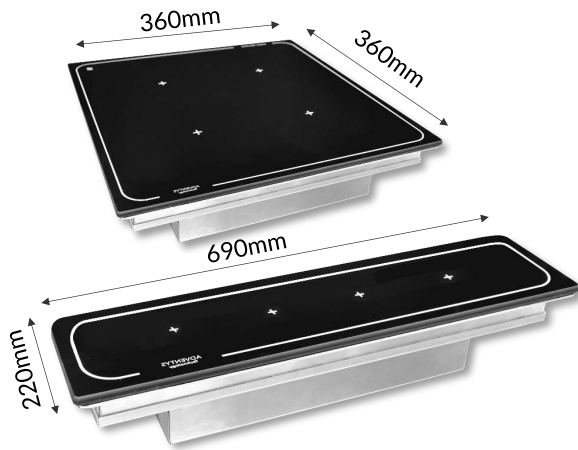

### KNL4 4000 / 8000 Multizone Induction Kit - 4 zones

### KNL4 4000 / 8000 S Saucier Multizone Induction Kit

- > Power 4000 ou 8000 watts
- > Glass dimensions **KNL4** 360 x 360 - **KNL4S** 220 x 690mm
- > Remote control panel - Capacitive touches and knob - 4 digits
- > Power supply 360-440V three-phase - 50-60Hz
- > Designed and made in France

> Cut out dimensions **KNL4**: 366 x 366mm

> Cut out dimensions **KNL4S**: 226 x 696 mm

KNL4 4000 Watts

ADV1825

KNL4 8000 Watts

ADV1669

KNL4 S 4000 Watts

ADV1826

KNL4 S 8000 Watts

ADV1712

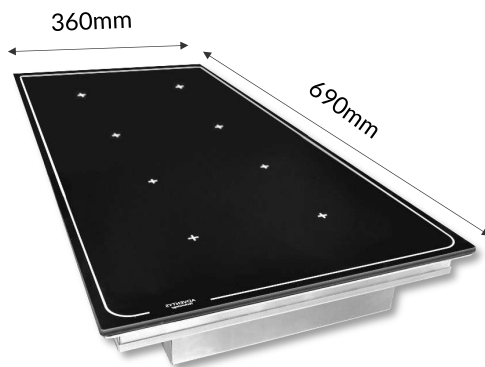

### KNL8 8000 / 16.000 Multizone Induction - 8 zones

- > Power 8000 ou 16.000 watts
- > Glass dimensions 360 x 690 mm
- > Remote control panel - Capacitive touches and knob - 4 digits
- > Power supply 360-440V three-phase - 50-60Hz
- > Designed and made in France

> Cut out dimensions : 366 x 696 mm

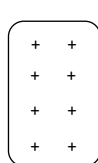

*Front to Back*

8000 Watts

ADV1827

16.000 Watts

ADV1670

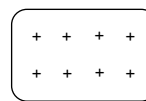

*Side by Side*

8000 Watts

ADV1828

16.000 Watts

ADV1781



### KNL16 16.000 / 32.000 Induction Multizone - 16 zones

- > Power 16.000 or 32.000 watts
- > Glass dimensions 360 x 690 mm
- > Remote control panel - Capacitive touches and knob - 4 digits
- > Power supply 360-440V three-phase - 50-60Hz
- > Designed and made in France

> Cut out dimensions : 696 x 696 mm

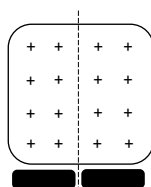

*Front to Back*

16.000 Watts

ADV1829

32.000 Watts

ADV1662

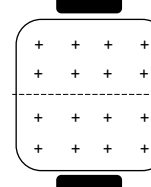

*Side by Side*

16.000 Watts

ADV1830

32.000 Watts

ADV1757



## Three-phase Kits

# Kits **PLANCHA** 200°C in 2 minutes

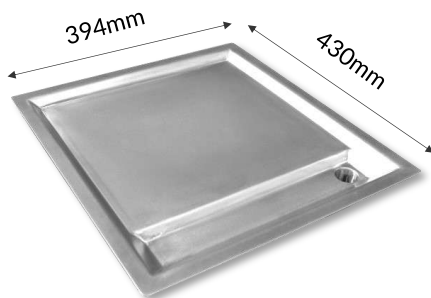

### P1IM 4000 Induction Plancha Kit - 1 zone

- > Power 4000 watts
- > Cooking surface 330 x 300 mm - Grill surface multilayer composite material
- > Product dimensions 394 x 430 x 140 mm
- > Knob remote control - 4 digits - Temperature display
- > Grease drain
- > Power supply 360-440V three-phase - 50-60Hz
- > Designed and made in France

> *Cut out dimensions: 362 x 398 mm*

**4000 Watts**

**ADV1653**

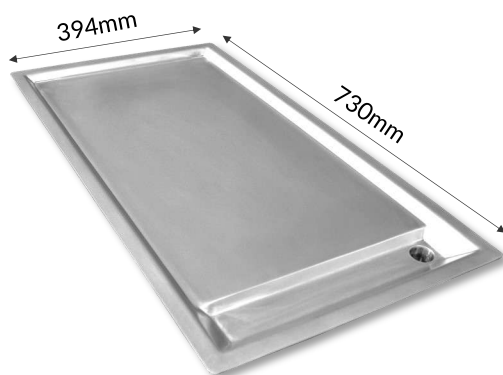

### P2IM 8000 Induction Plancha Kit - 2 zones

- > Power 8000 watts
- > Cooking surface 330 x 300 mm - Grill surface multilayer composite material
- > Product dimensions 730 x 394 x 157,5 mm
- > Knob remote control - 4 digits - Temperature display
- > Power supply 360-440V three-phase - 50-60Hz
- > Grease drain
- > Designed and made in France

> *Cut out dimensions: 362 x 698 mm*

**8000 Watts**

**ADV1654**

**600 burgers**  
**/Hours**

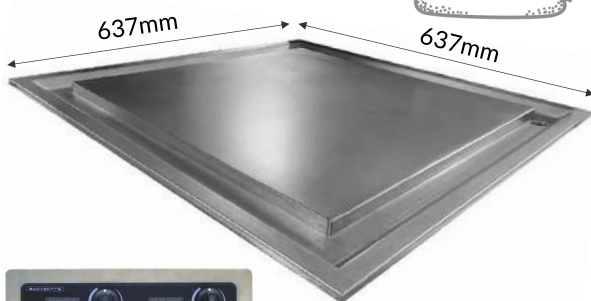

### P4IM 16000 Induction Plancha Kit - 2 zones

- > Power 16.000 watts
- > Cooking surface 330 x 300 mm - Grill surface multilayer composite material
- > Product dimensions 800 x 800 x 183 mm
- > 2x Knob remote control - 4 digits - Temperature display
- > Power supply 360-440V three-phase - 50-60Hz
- > Grease drain
- > Designed and made in France

> *Cut out dimensions 637 x 637 mm*

**16.000 Watts**

**ADV1397**

# Your custom-made projects

*By Adventys*

Adventys supports you in your custom-made projects. We put our know-how at your service to help you make your ideas come true. Our industrial sheet metal activity and our wide product ranges allow us to offer you different solutions, enabla- tures to be installed on cupboards, unique cooking bespoke. We can also adapt to existing configurations.

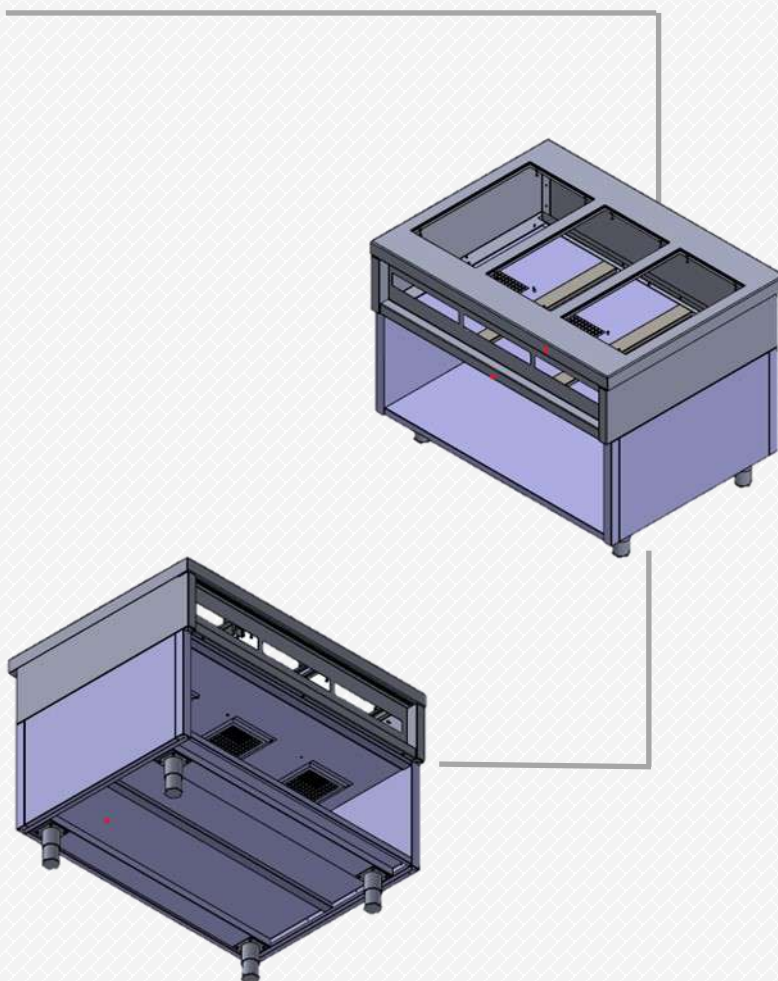
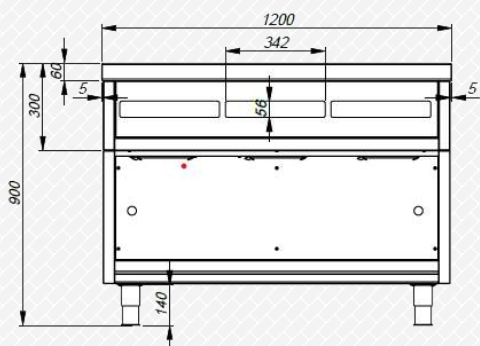

## **QUOTE IN 48H**

**Adventys guarantee :**

Technical support on site

A dedicated contact person

C.E certified cooking bespoke

Induction after-sales service parts available within 24H

*Custom-made stove*  
*For french restaurant Le Palmier in Dijon*  
*Collab with Perrier*



# our Workshops



## Design offices

ADVENTYS has **CAD resources** to produce precise mechanical parts and validate their assembly by 3D simulation, a **guarantee of manufacturing quality**. We also have electronic design resources that are constantly updated through the acquisition of **new development tools and the training** of our technicians and engineers. An endurance test room confirms the **reliability** of our devices before they are marketed.

## Metal shop

The desire to obtain a careful design of our products requires significant investment in the field of **fine sheet metal**. Thanks to that, our products are considered as **references on the market**. Our modern machine park (digital punching and folding machine, stamping tools) permits us to produce, entirely **in our premises**, the stainless steel components that make up our product.



## Electronic workshop

For a full control of reliability, ADVENTYS has chosen to **produce its electronic boards internally** using automated machines for component assembly, welding and testing. The manufacturing process is certified **ISO 9001: 2015**.

## Assembly lines

The cooking appliances marketed by ADVENTYS are **assembled and tested** on our four assembly lines, with an **annual capacity** of more than **10,000 products**, in strict compliance with internal procedures and professional safety standards.



## Show-room

A **150m<sup>2</sup> showroom** as well as a demonstration kitchen make it possible to present the different ranges of appliances sold and to organize **commercial or technical training** for our customers. We welcome our customers all year round to take guided tours of our factory.







*Restaurant Le Manoir de la Régate  
Chef Mathieu Pérou - Etoilé Michelin  
Réalisation EquipService et Lanef Pro*



**ATLANTIS**  
DUBAI

**FOLLOW US !**



[www.adventys.com](http://www.adventys.com)



[contact@adventys.com](mailto:contact@adventys.com)



+33 3 80 20 46 15

Route de Pagny - 21250 SEURRE - France

*SAS Capital de 525.300€ - Siret 483 445 011 00016*